	EDGE 2.4.0	
	User Manual	PAGE 1/46

User manual

EDGE 2.4.0 User Manual

Table of Contents

1. INTRODUCTION.....	5
2. EDGE OBJECTIVES	6
2.1. About GDML.....	6
2.2. Caution and limit of warranties	6
2.3. Main functionalities	7
2.4. Supported formats	7
2.4.1. <i>Import</i>	<i>7</i>
2.4.2. <i>Export and CSG-to-B-Rep decomposition</i>	<i>8</i>
3. USING EDGE	9
3.1. Supported platforms	9
3.2. Starting Edge	9
3.3. EDGE Main Window.....	10
3.3.1. <i>Main Menu</i>	<i>10</i>
3.3.2. <i>General Toolbar</i>	<i>11</i>
4. PREFERENCES	12
4.1. GDML default material preferences	12
4.2. GDML writer preferences.....	13
4.3. General preferences	14
4.4. System preferences	15
5. GEOMETRY EDITION	16
5.1. The Geometry edition perspective	16
5.1.1. <i>Shapes tree</i>	<i>17</i>
5.1.2. <i>Properties panel.....</i>	<i>18</i>
5.1.3. <i>3D View</i>	<i>19</i>
5.2. Available geometric shapes	20
5.3. Other shapes available	24
5.3.1. <i>Tessellated Solid.....</i>	<i>24</i>
5.3.2. <i>Assemblies</i>	<i>24</i>
5.3.3. <i>GDML file.....</i>	<i>25</i>
5.4. Edition of the geometry	25
5.4.1. <i>Creating/adding a new shape.....</i>	<i>25</i>
5.4.2. <i>Transforming several elements</i>	<i>27</i>
5.5. Model operations.....	28
5.5.1. <i>GDML File validity check.....</i>	<i>28</i>
5.5.2. <i>Check for overlaps</i>	<i>28</i>
5.5.3. <i>Compute volume.....</i>	<i>29</i>
5.5.4. <i>Reorganise model.....</i>	<i>29</i>
5.5.5. <i>SSAM – Sector Shielding Analysis Module</i>	<i>30</i>
6. MATERIAL DEFINITION.....	37
6.1. About GDML materials	37
6.2. Materials list.....	38
6.3. Geant4 materials.....	39
6.4. Material editor	39
7. MATERIALS ASSIGNMENT.....	41
7.1. Materials list.....	41
7.2. Material selection	42
8. GDML FILE PERSPECTIVE	43
9. ANNEX A: EXAMPLE OF MATERIALS DESCRIPTION	44
10. ANNEX B – EXAMPLE OF CSV FILE FOR THE DOSE COMPUTATION.....	45

	EDGE 2.4.0	
	User Manual	PAGE 3/46

Summary

Objectives

The objective of this document is to describe the aim of EDGE, how to use it and the main concepts behind it.

Diffusion

Nom	Organization
Users of Edge	-

Changes record

Version	Revision	Date	Author	Modification
1	0	03/09/2015	Arnaud Trouche	Document creation
1	1	06/06/2016	Arnaud Trouche	Update with latest developments
1	2	10/06/2016	Elsa Kress	Update
2	0	05/08/2016	Arnaud Trouche	Add the material edition, rearrangement
2	1	05/08/2016	Elsa Kress	Update
2	2	02/11/2016	Arnaud Trouche	Update
3	0	05/10/2017	Amandine Champlain	Update to the new version of the software
3	1	09/04/2018	Arnaud Trouche	Updates for EDGE 2.2.0
4	0	05/07/2018	Arnaud Trouche	Updates for EDGE 2.3.0
4	1	15/10/2018	Arnaud Trouche	Updates for EDGE 2.3.2
4	2	12/03/2019	Arnaud Trouche Benjamin Jeanty-Ruard	Updates for EDGE 2.4.0

	EDGE 2.4.0	
	User Manual	PAGE 5/46

1. Introduction

This document describes the EDGE CAD editor, the context and the concepts behind its conception, as well as its use.

Reference documents

[RD1] GDML Web page, <http://gdml.web.cern.ch/GDML/>

[RD2] Geant4 Web page, <https://geant4.web.cern.ch/geant4/>

[RD3] SpaceSuite Web site, www.space-suite.com

[RD4] Santin G. et al., "GRAS: A General-Purpose 3-D Modular Simulation Tool for Space Environment Effects Analysis", IEEE Trans. Nucl. Sci., Vol. 52, No. 6, December 2005

[RD5] Jeanty-Ruard B. et al, "Advanced CAD Tool and experimental integration of GRAS/Geant4 for internal charging analysis in SPIS", Proceedings, 14th Spacecraft Charging Technology Conference, ESA/ESTEC, Noordwijk, NL, 04-08 APRIL 2016

[RD6] Keridwen open-source IME Web site, www.keridwen.org

[RD7] SPINE community Web site, www.spis.org

[RD8] EDGE project Web page, <http://www.space-suite.com/edge>

[RD9] GDML USER'S GUIDE; Version 2.7; <http://gdml.web.cern.ch/GDML/doc/GDMLmanual.pdf>

Acronyms and abbreviations

- B-Rep: Boundary Representation
- CAD: Computer Assisted Design
- CSG: Constructive Solid Geometry
- EDGE: Extended Gdml Editor
- GDML: Geometry Description Mark-up Language
- GUI: Graphical User Interface
- IME: Integrated Modelling Environment
- STL: STereo-Lithography
- UNV: Universal File Format
- XML: Extensive Markup Language

Status: final	Date: 12/03/2019
----------------------	-------------------------

	EDGE 2.4.0	
	User Manual	PAGE 6/46

2. EDGE objectives

EDGE — for **ExtendeD Gdml Editor** — is an easy-to-use GDML-based CAD editor. It provides a powerful and flexible CSG model fully compliant with the GDML CAD format [RD1], used by numerous particle-matter interactions analysis tools based on the Geant4 library [RD2]. EDGE provides also various import/export capabilities from/to B-Rep based CAD formats.

EDGE has been developed by Artenum in the frame of its internal R&D activities and is available through several of its commercial services offers, like SpaceSuite [RD3].

2.1. About GDML

Based on XML syntax, the **Geometry Description Markup Language (GDML)** is the reference language used to describe geometrical models (i.e. CAD models) for radiation modelling tools like [Geant4](#) [RD2], [ESA/GRAS](#) [RD4] or SPIS-IC [RD5]. GDML is based on a rich CSG approach and can be used to create complex and realistic geometrical systems to be used for various purposes.

As an XML-based language, it can be fairly well read by humans and it is quite simple to parse it. However, one of its limits is that it is difficult to visualise what a GDML file is going to produce just by looking at it in a tailored sense, i.e. as a 3D geometrical system. Although some viewers or editors exist, only a few of them are publicly available, and they are not user-friendly or incomplete. Moreover, most GDML editors so far cannot handle the depth hierarchy used in GDML.

Therefore, Artenum decided to develop a GDML editor based on the IME Keridwen [RD6]. Its aim is to propose a simple-to-use, cross-platform editor with good capacities of visualization.

2.2. Caution and limit of warranties

The present document is intended to be a simple User Manual (UM) to help the user to use EDGE in basic mode to create CAD modelling. This document does not attempt to provide to the future EDGE user the whole expertise and knowledge needed to create a correct CAD modelling. The final confidence in the relevance and accuracy of the CAD model depends on the user expertise and remains his responsibility.

FOR THIS REASON, THERE IS NO WARRANTY FOR THE PROGRAM, TO THE EXTENT PERMITTED BY APPLICABLE LAW. EXCEPT WHEN OTHERWISE STATED IN WRITING, THE COPYRIGHT HOLDERS AND/OR OTHER PARTIES PROVIDE THE PROGRAM "AS IS" WITHOUT WARRANTY OF ANY KIND, EITHER EXPRESSED OR IMPLIED, INCLUDING, BUT NOT LIMITED TO, THE IMPLIED WARRANTIES OF MERCHANTABILITY AND FITNESS FOR A PARTICULAR PURPOSE. THE ENTIRE RISK AS TO THE QUALITY AND PERFORMANCE OF THE PROGRAM IS WITH YOU. SHOULD THE PROGRAM PROVE DEFECTIVE, YOU ASSUME THE COST OF ALL NECESSARY SERVICING, REPAIR OR

Status: final	Date: 12/03/2019
----------------------	-------------------------

CORRECTION. For an improved handling of the key concept addressed by EDGE, we strongly recommend to contact SpaceSuite.

NB: for further information, please contact the SpaceSuite team on <http://www.space-suite.com> or at contact@space-suite.com.

2.3. Main functionalities

EDGE can either create or load a complete GDML model. In both cases, the user can modify the properties of all the shapes or add new shapes. Moreover, shapes also have position and orientation properties that allow placing them correctly. To facilitate the work for the user, position and orientation can be applied to several objects at the same time. EDGE handles complex hierarchies with several levels of depth.

EDGE also allows editing and attributing material properties to each shape individually. At any time, the user can see the results of his work thanks to the real-time 3D.

After editing his file, the user can save the result back to GDML but he can also export it to the B-Rep .geo format (the file format of Gmsh)¹.

2.4. Supported formats

2.4.1. Import

EDGE support natively the GDML format in reading and writing, but is also able to import numerous B-Rep CAD formats like Gmsh's geo or STEP-AP 203/214 and tessellated solids in STL or UNV files. These import/export capabilities open interoperability bridges with other CAD tools and multi-physics simulation software.

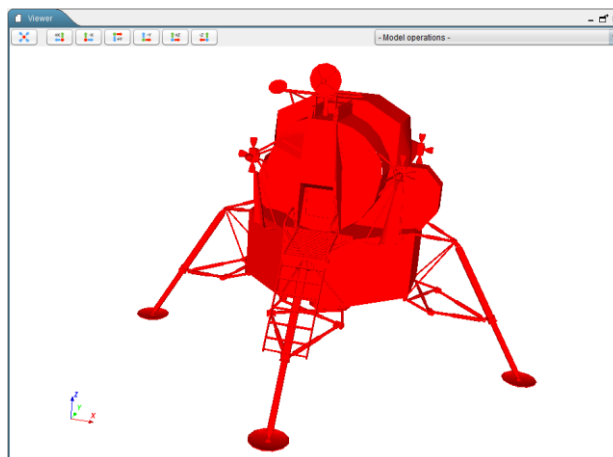

Figure 1: Example of imported STEP-AP model inside EDGE

¹ <http://geuz.org/gmsh/>

2.4.2. Export and CSG-to-B-Rep decomposition

EDGE is able to convert GDML models into an equivalent Gmsh's geo file, fully compliant with tailored applications like SPIS [RD7]. This conversion is not done by tessellation but by a proper CSG to B-Rep decomposition with the view in Gmsh (on the top of Figure 2) of a model initially defined in EDGE (on the bottom of Figure 2).

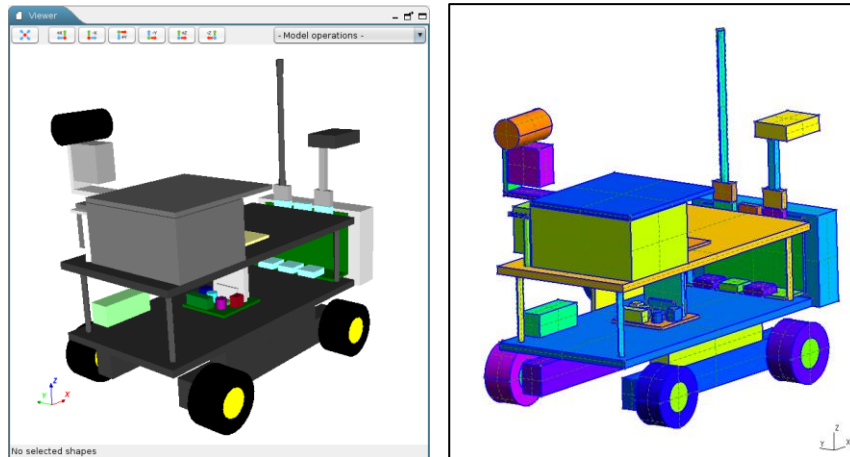



Figure 2: CSG to B-Rep decomposition of a GDML model defined in EDGE (left) visualized in Gmsh (right)

	EDGE 2.4.0	
	User Manual	PAGE 9/46

3. Using EDGE

3.1. Supported platforms

Currently, EDGE can be used on most 64bits Linux platforms, Microsoft Windows-7-8-10 32/64bits and OSX/MacOS 10.10.5 and higher 64bits.

3.2. Starting Edge

The application as well as the present User Manual can be downloaded from the [SpaceSuite](#) Web page [RD8].

Once downloaded, the zip file containing the EDGE snapshot has to be extracted on the machine where it will be used on to ensure that the software is executable.

NB: on Windows systems, the native unzipping method may encounter issues when unzipping EDGE. You may want to use third-party application to avoid issues. The unzip has been successfully tested with the 7Zip application.

i. Linux

Depending on your precise Linux distribution, double-clicking on the *Edge.sh* file may launch the application correctly (see below for more details on Gnome environments).

To start the application, it is also possible to open a terminal and just execute `./Edge.sh` in the application directory. It is then possible to indicate launching options, see the Command-line launching options paragraph below.

*NB: on recent Linux distributions with Gnome, double-clicking on the *Edge.sh* displays the content of the file instead of launching it. You can modify this behaviour by going to the file manager preferences and changing the way executable files are handled.*

ii. MacOS

To start the application, you need to open a terminal and execute the *Edge.sh* file. It is possible to indicate launching options, see the Command-line launching options paragraph below.

iii. Windows

Double-clicking on the *Edge.bat* will launch the application. To use more advanced launching options, you can open a command invite and type *Edge.bat*. Options can be provided, see the Command-line launching options paragraph below

iv. Command-line launching options

It is possible to use options to launch EDGE. The options can be added (one at a time) after the launching command. To know all the available options, the option `-h` can be used (such as `./Edge.sh -h` or `Edge.bat -h`).

Status: final	Date: 12/03/2019
----------------------	-------------------------

```
-f path/to/gdml/file.gdml
```

This option enables loading the given file at the same time than the application.

3.3. EDGE Main Window

The GUI of EDGE is intuitive and based on the concept of “perspectives”, where the modelled system can be viewed and handled from different approach or points of view, like the edition of the geometrical model, the definition of material properties or the assignment of these materials to their correct geometric shape.

As shows the Figure 3, some elements of the graphical interface are common for all perspectives:

- **① Main Menu** corresponds to main control menu of the application.
- **② General Toolbar** presents shortcut buttons to open and save (on the left) a file and also allows switching from a perspective to another (on the right). This toolbar also grants access to the preferences panel.

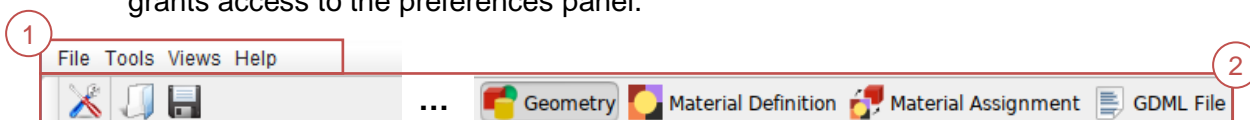

Figure 3: Main elements of EDGE window (here in the geometry perspective)

3.3.1. Main Menu

i. File menu

The *File* menu (shown on the right) allows opening and saving GDML files and also various import and export options. An option also permits opening recent files. Finally the exit option enables leaving the application.

Please note that EDGE can only load one file at a time. When opening a GDML file, if there are unsaved modifications, the application will propose to save this work before replacing it by the new opened file.

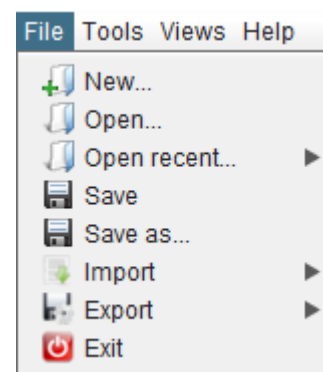

In its trial version, EDGE does not allow exporting or saving to GDML.

NB: EDGE tries to load all files, even if there are inconsistencies. For example, if a file contains two solids with the same name, EDGE will only consider the last element with this name and inform about this issue and the chosen resolution.

ii. Tools menu

The *Tools* menu (shown on the right) offers various tools and shortcuts. From here, you can access the preferences panel presented in section 4. The console log is displaying various messages from the application such as errors and warnings.

With this menu, it is also possible to apply corrective patch to EDGE or install new feature plugin. To do so, click on the correct item and a file choose will appear and asks where the patch/plugin is located. Once installed, it is recommended to restart the application.

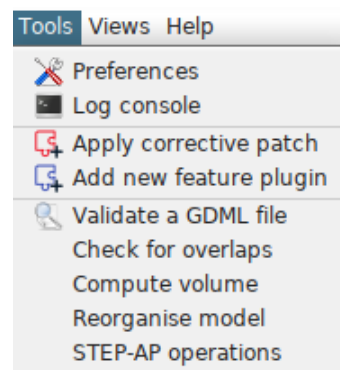

This menu also offers access to various tools and model computation operations which are described in more details in section 5.5.

iii. Other menus

The *Views* menu allows switching from one of the perspectives presented earlier to another. The *Help* menu is useful to access this user manual directly from within the application. This menu also offers the about screen, resuming information about the software.

3.3.2. General Toolbar

The left part of this toolbar allows the user, thanks to three buttons, to access the Preferences, presented in section 4, and to easily open and save a file without opening the File menu presented in 3.3.1.

The right part of this toolbar presents four buttons allowing the user to switch between the four main perspectives of EDGE: the Geometry edition (visible on Figure 8, see section 5), the Material definition (see section 6), the Material affectation one (see section 7 for more information) and finally the GDML File perspective (see section 8).

4. Preferences

The Preferences dialog box allows the setting of the applications options. For each option, a “Reset to default” button allows switching back to the initial value.

At the first launch of the application, the Preferences dialog box is shown and enables the user to change the default parameters right away.

4.1. GDML default material preferences

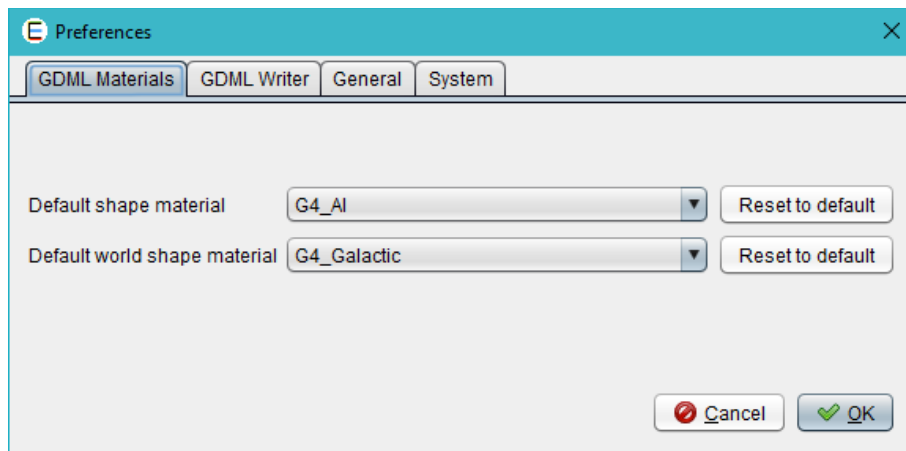

Figure 4: GDML default materials preferences

The first tab — shown on Figure 4 — offers options concerning the default GDML materials used in the application. Indeed, when a new shape is created in EDGE, a default material is assigned to it that can be changed later on in the Material Assignment perspective (see section 7 page 41). Here, it is possible to select which material will be assigned to the world element and to other elements. The selection can be performed from within the EDGE default materials list and the Geant4 default materials list.

4.2. GDML writer preferences

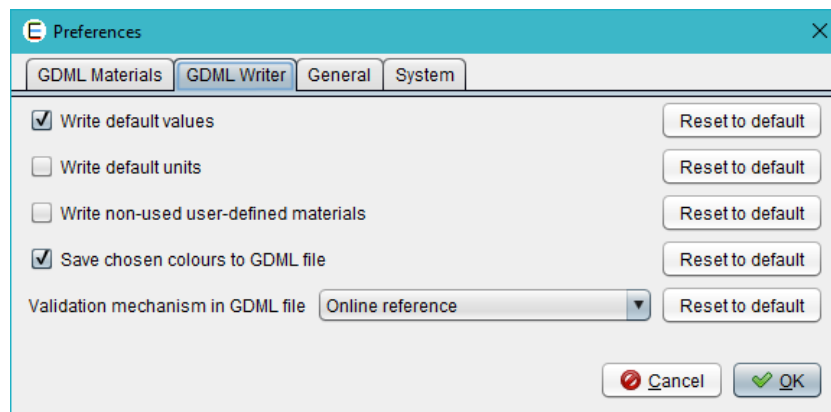

Figure 5: GDML writer preferences

The second tab, shown on Figure 5, sets parameters for the GDML writer:

- **Write default values:** if this option is selected, the values for optional fields will be written even if they equal to the default value — it is the case for example for the position and orientation (0 is the default value);
- **Write default units:** if this option is selected, the units will always be specified inside the GDML file even if they equal to the GDML default units (mm for lengths and radians for angles);
- **Write non-used user-defined materials:** if this option is selected and that the user has defined materials which are not assigned to a geometric shape, those materials will be stored in the GDML file anyway;
- **Save chosen colours to GDML file:** if this option is selected, the colours chosen in the Geometry panel will be saved to the GDML file using the `<auxiliary>` tag, and then when loading the file the colours will be the same. Be careful, the content of the `<auxiliary>` tag is not interpreted by the Geant4 numerical kernel. This tag is usually properly treated by the client code as explained in the GDML user manual [RD9]
- **Validation mechanism in GDML file:** Choose the reference to the GDML file validator (.xsd) defined in the GDML file after the save action in EDGE. The choices are:
 - online (the validation process requires an internet connection when the file in other tools is loaded);
 - local (the validation is made locally with a validator file embedded on the local computer. The saved GDML file can only be used on this computer as long as the software is not moved);
 - none (no reference to a GDML file validator is written, then no validation will be processed when the GDML file will be used by other tools).

4.3. General preferences

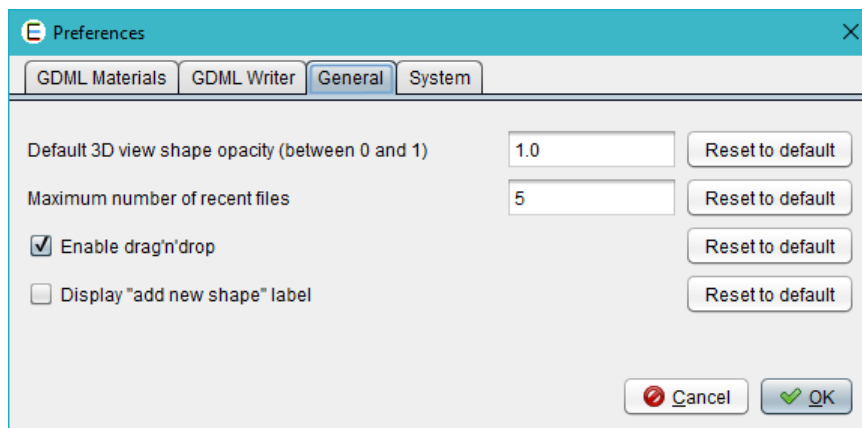

Figure 6: General preferences

The third tab offers more general usability preferences, as shown on Figure 6:

- **Default 3D view shape opacity:** sets the default opacity used when adding a new shape to the 3D view. Indeed, a colour is automatically chosen for every new shape and this setting will choose the opacity for this colour. The value 0.0 is fully transparent while the value 1.0 is fully opaque. Please note that this setting will not change the opacity of the shapes already displayed in the 3D view;
- **Maximum number of recent files:** this option controls the number of recent files stored by EDGE and accessible in the *Open recent...* menu.
- **Enable drag'n'drop:** enables the possibility to move the elements in the Shapes tree using drag and drop gesture with the mouse. It facilitates the modification of the hierarchy — to avoid unwanted modifications, this option is disabled by default;
- **Display “Add new shape” labels:** display shortcut labels in the shapes tree of the Geometry Edition perspective. These labels help to gain time to add new shape but this option is disabled by default to gain cleanliness.

4.4. System preferences

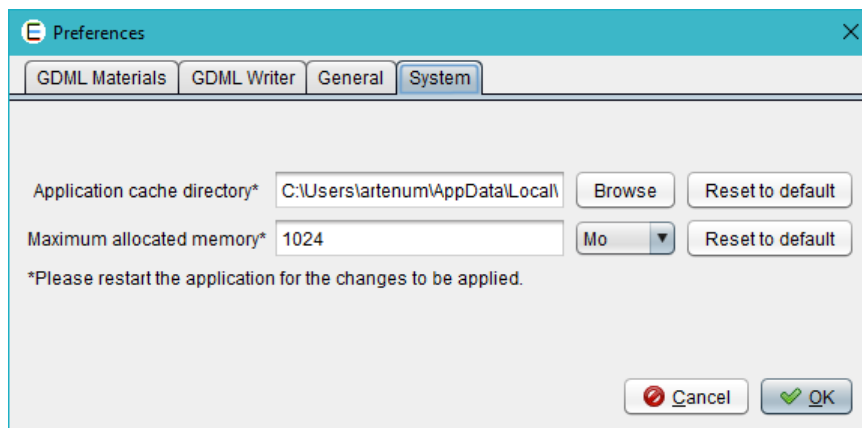

Figure 7: System options

The last tab sets preferences for the system, as shown on Figure 7. The user can choose:

- **Application cache directory:** by clicking on the “Browse” button, the user can choose the path where the application stores its temporary files. It may be useful to change this setting if you do not have write access to your temporary folder (by default EDGE uses the operating system default temporary folder);
- **Maximum allocated memory:** the user can choose the value and unit (Mo or Go) of the available memory for EDGE. It can be useful to increase this value when loading very big files, without exceeding the system maximum capabilities.
NB: As mentioned in section 3.2. iii, this option will not be taken into account when launching EDGE with the EDGE.exe on Windows systems.

5. Geometry Edition

The Geometry perspective is the main perspective of EDGE since it allows the creation and the edition of geometrical elements.

5.1. The Geometry edition perspective

It is the main perspective of EDGE displayed by default at the launching. It has three main panels to edit the geometry, as shows Figure 8:

- ① **Shapes Tree** panel, to visualise and edit the list of geometric shapes;
- ② **Properties** panel, to edit the properties of the currently selected shape;
- ③ **3D Viewer** panel, present only for the geometrical edition and material affectation perspectives, provides a 3D view of the modelled system.

These panels, as well as the 3D View panel, can be moved, detached or maximized at the user's liking using the buttons on their top right corner.

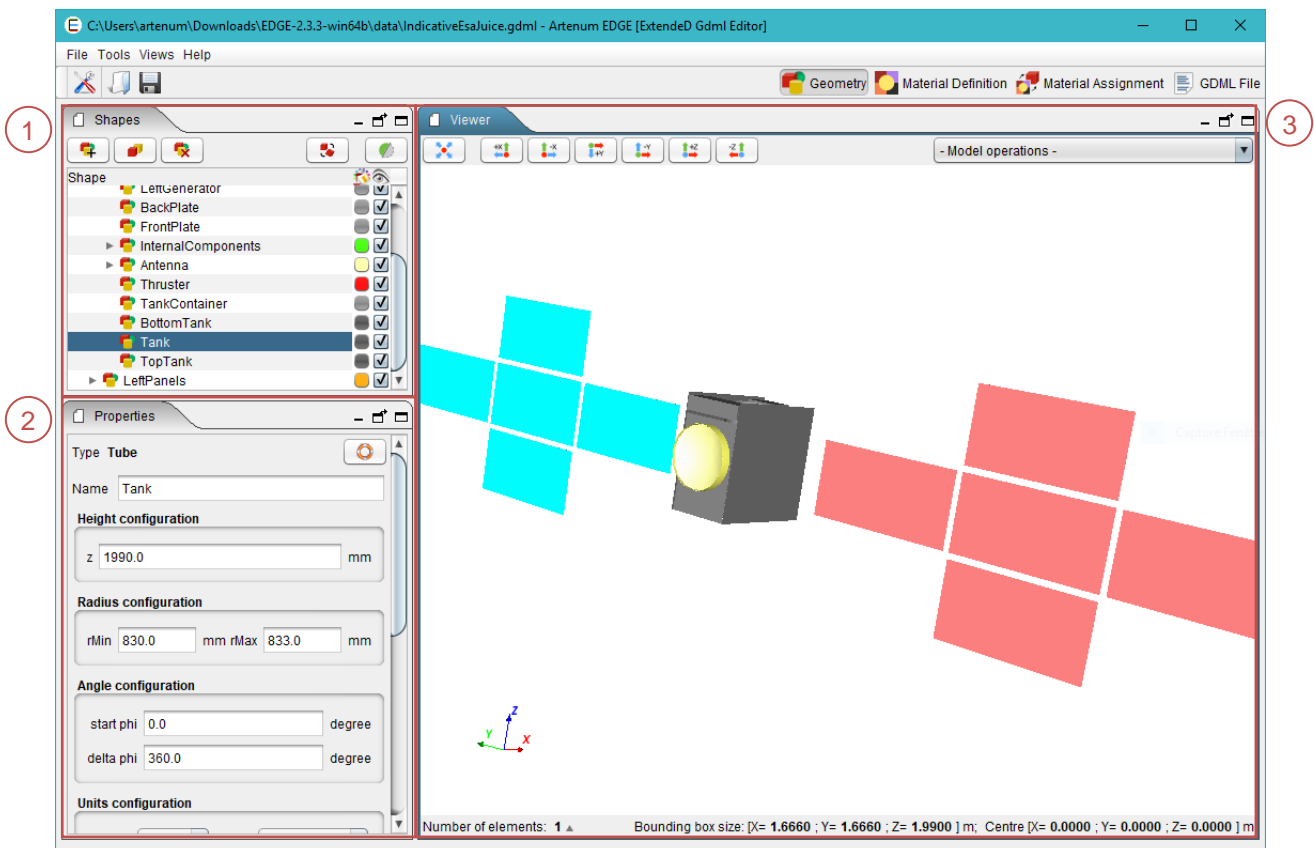

Figure 8: EDGE geometry edition view

5.1.1. Shapes tree

The Shapes tree lists all the shapes currently defined in the geometrical model and displayed in the 3D scene. It also shows the hierarchy of the shapes. The shape(s) currently selected is (are) highlighted in the 3D view on the right with a red box. It is also possible to move one geometry element and all its children elements to another logical location in the geometry tree. This feature is available only if the drag'n'drop option has been enabled in the Preferences, see section 4.

On the right of each shape, a click on the coloured box opens a dialog that allows changing the colour of the shape in the 3D view. It is also possible to change the transparency of the selected element in this dialog box, as shown on Figure 9. A checkbox on the right controls the visibility of the object in the 3D view.

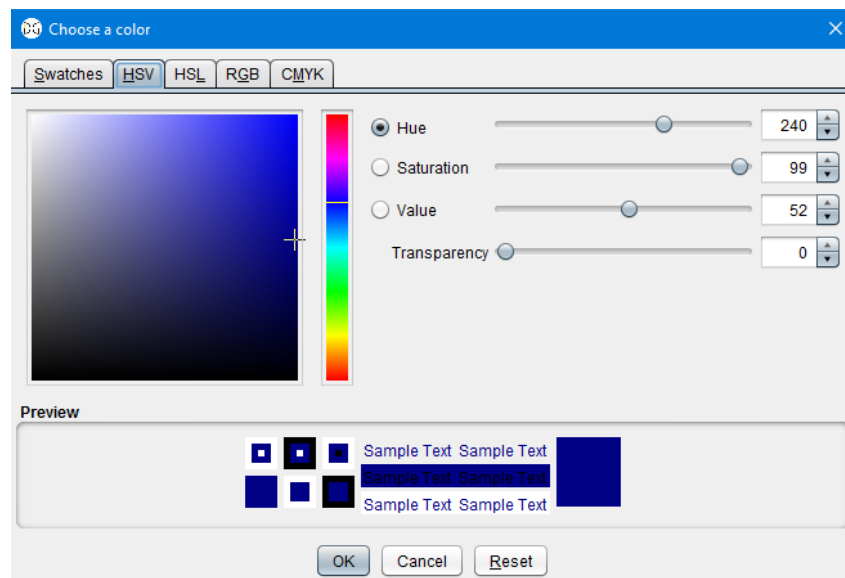







Figure 9: Colour changing dialog box

On top of the tree, five buttons are used to control the shapes:

- The three buttons on the left side allow adding, duplicating and/or removing shapes. The first one () opens a dialog box to add a new shape to the tree (more details in section 5.4.1). The second one () duplicates the selected shape(s) and the third one () deletes all the shapes currently selected in the tree.
- The two buttons on the right side allow performing actions on the currently selected shape(s). The first one () opens a dialog box to apply a transformation to all the elements currently selected (see section 5.4). The second one () offers the possibility to use a clipping filter. This button triggers the apparition of a dialog box allowing the user to set the parameters of the clipping filter, see Figure 10. This filter performs a cut in the geometry to view more precisely the inner geometry of the modelled system.

The clipping is set with the coordinates of a centre point and a normal direction. It will keep the geometric representation of the selected element in the half-space defined by this point and the normal. To get a more interactive setting, you can select the “*Display 3D control widget*” that will display an interactive control in the 3D view to change the clipping. These 3D controls of the filter are materialised by a sphere (representing the centre of the clipping operation) and an axis with two arrows (representing the normal direction), see Figure 10.

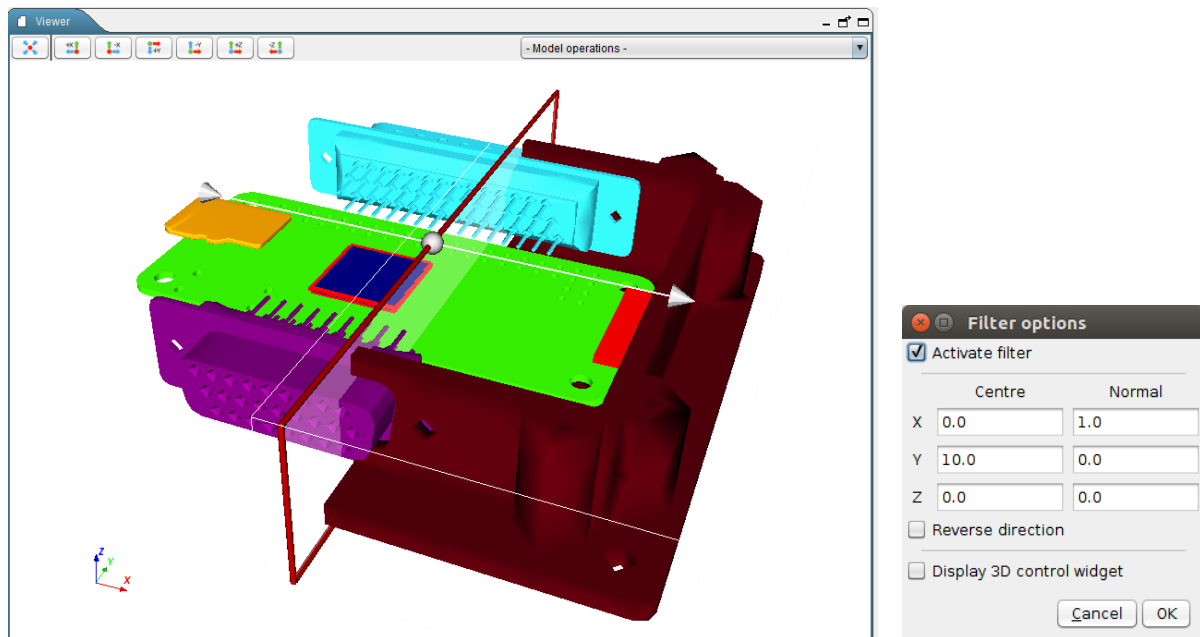



Figure 10: Clipping filter applied on Raspberry Pi Zero housing with the 3D control widget enabled (left) and clipping control pane (right)

5.1.2. Properties panel

This panel shows the properties of the shape currently selected in the Shapes tree. It shows properties only if there is one — and only one — shape selected. Depending on the shape selected, the properties displayed change accordingly.

The user can thus define the dimensions of the shape. For each shape, parameters vary and explanatory schemes are presented in section 5.2. These pictures are also available in the software by clicking on the “Help” button ().

This panel shows also fields to choose the position and orientation of the object and the unit of measure. The unit for parameters, positions and rotations can be changed and an automatic conversion of values is proposed. The default units are millimetres (mm) for lengths and radians (rad) for angles.

i. Thickness parameter and Boolean operations

Some elements — such as boxes, ellipsoids, orbs, parallelepipeds and trapezoids — have an additional useful parameter (not present in GDML) called thickness. If a shape has a thickness defined (different from 0), then the export of this shape will be done using Boolean operations (a subtraction between the outer element and the inner element). It allows the user to gain time for this kind of operations.

This kind of shape can be very useful during the definition of radiation analysis. The user shall be aware that this thickness value is not a GDML parameter, which means that setting this parameter to a value different from zero will result, in the GDML file, to the corresponding Boolean operation. The little warning sign (⚠) next to the name of this parameter is present to remind the user of this.

If an EDGE file containing a shape with a defined thickness (different from 0) has been saved and is then loaded again, the user must note that the concerned shape will be displayed as Boolean operations. It means that when the user will click on the corresponding shape, it will be displayed as a Boolean operation and the user will not be able to edit it and change its dimensions, position and rotation parameters.

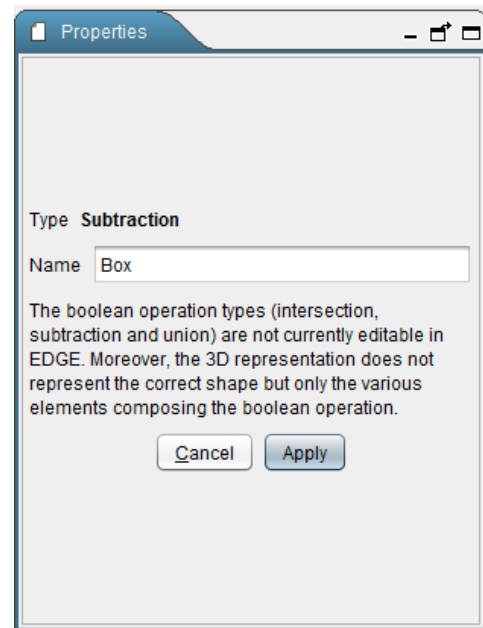

5.1.3. 3D View







The 3D view is showing in real-time the product of the GDML model. It is possible to interact with the view using the mouse to control it:

- Left click (hold) and movement: rotate the scene;
- Wheel (hold) and movement: translate the scene;
- Right click (hold) and movement: zoom;

Or the keyboard:

- “R” resets the view and shows all the shapes of the scene;
- “I” to zoom in;
- “O” to zoom out;
- “W” displays the shapes as wireframes;
- “S” displays the shapes as solid;
- The up/down/left/right arrows rotate the scene.

The buttons at the top of the view also facilitate its handling:

-  resets the view and shows all the shapes of the scene (“R” key shortcut);
-  aligns the view along +X axis;
-  aligns the view along -X axis;
-  aligns the view along +Y axis;
-  aligns the view along -Y axis;
-  aligns the view along +Z axis;
-  aligns the view along -Z axis.

NB: Sometimes, at the launch of the software, the 3D view is not correctly initialised. To refresh it, change perspective to another one and come back to the initial perspective, the 3D view is now correctly initialised. It can also happen when using several screen and moving the application from one screen to another one.

On top of the 3D view, a drop-down menu allows the user to choose a model operation to launch (cf. section 5.5). These operations are also available through the Tools menu presented in section 3.3.1.i.

On the bottom of the 3D view, an information bar displays useful information about the current selection: the number of selected elements as well as the size and the position of the bounding box — the red box around selected elements. It is possible to click on the number of selected elements to display a list of the currently selected elements as shown on Figure 11.

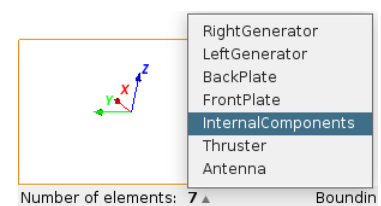

Figure 11: List of selected elements

5.2. Available geometric shapes

EDGE handles several primitive geometric shapes as shown on Figure 12. Other kind of shapes are also supported and presented in section 5.3.



Figure 12: Available shapes

The figures from Figure 13 to Figure 24 on the following pages present the parameters of all the shapes handled by EDGE. For concerned elements, the parameter *thickness* is explained.

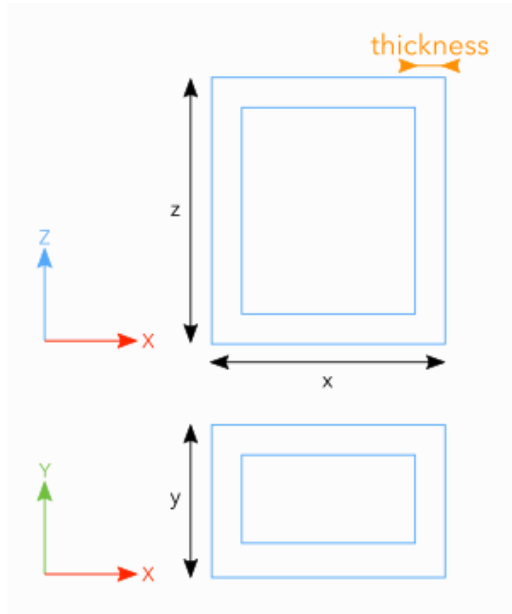

Figure 13: Box parameters

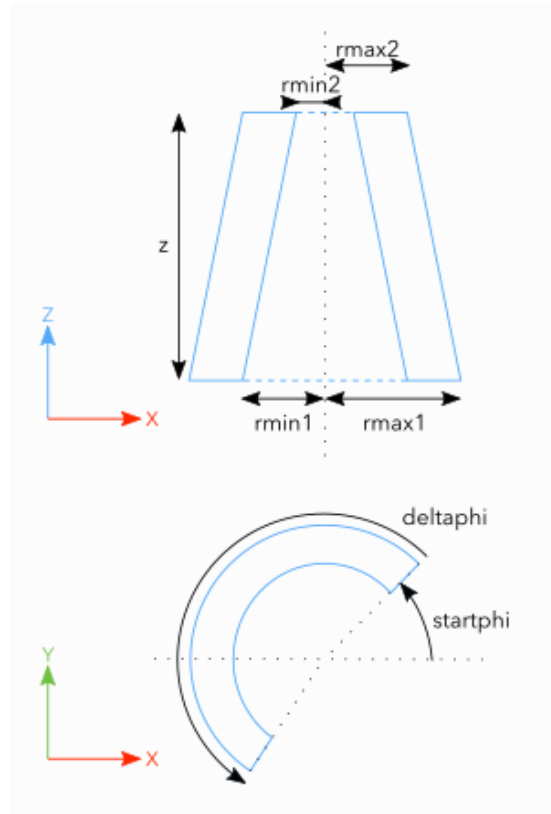

Figure 14: Cone parameters

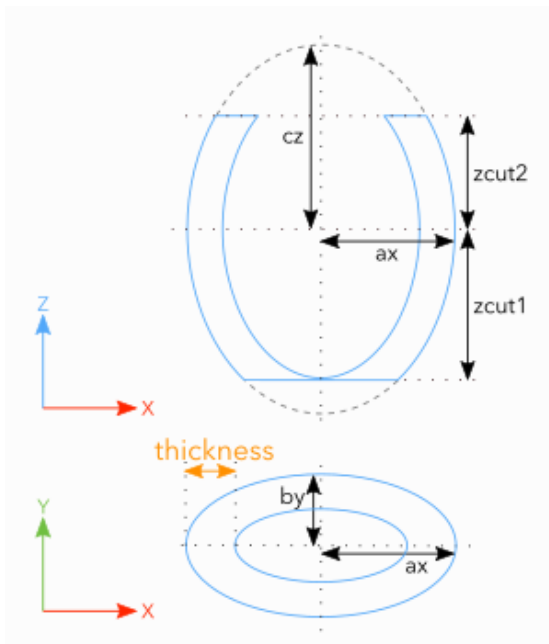

Figure 15: Ellipsoid parameters

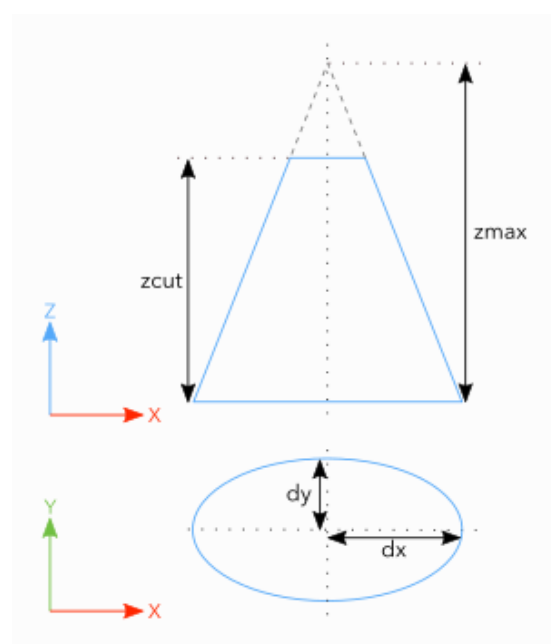

Figure 16: Elliptical cone parameters

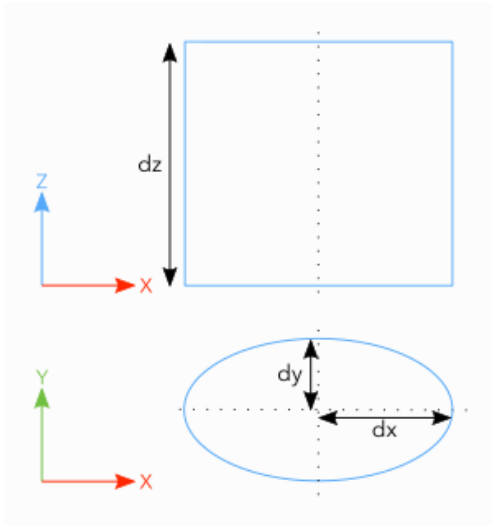

Figure 17: Elliptical tube parameters

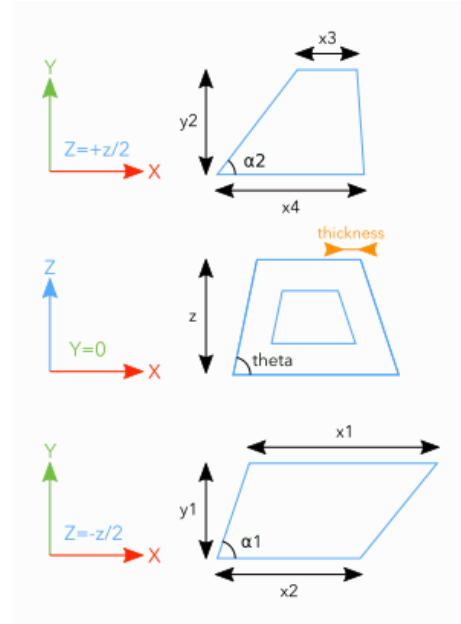

Figure 18: General trapezoid parameters

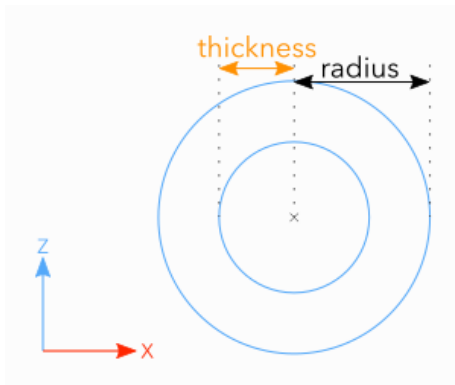

Figure 19: Orb parameters

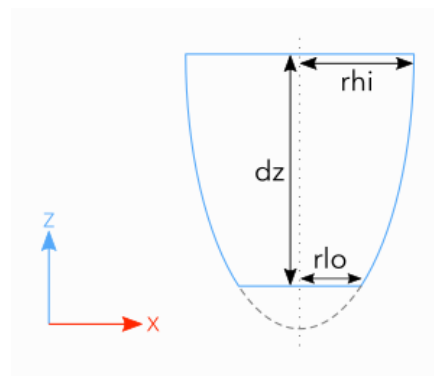

Figure 20: Paraboloid parameters

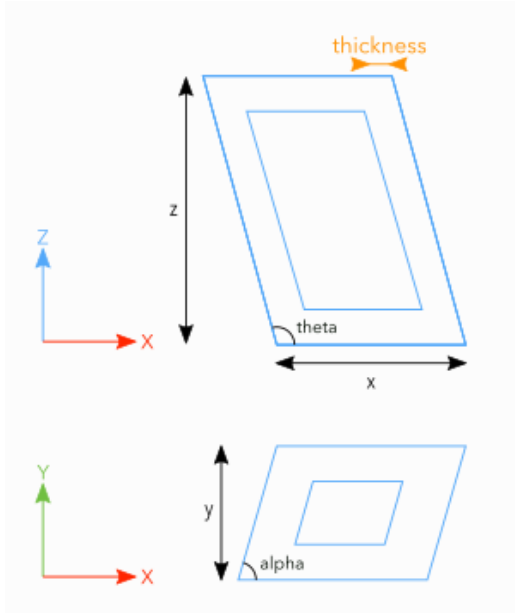

Figure 21: Parallelepiped parameters

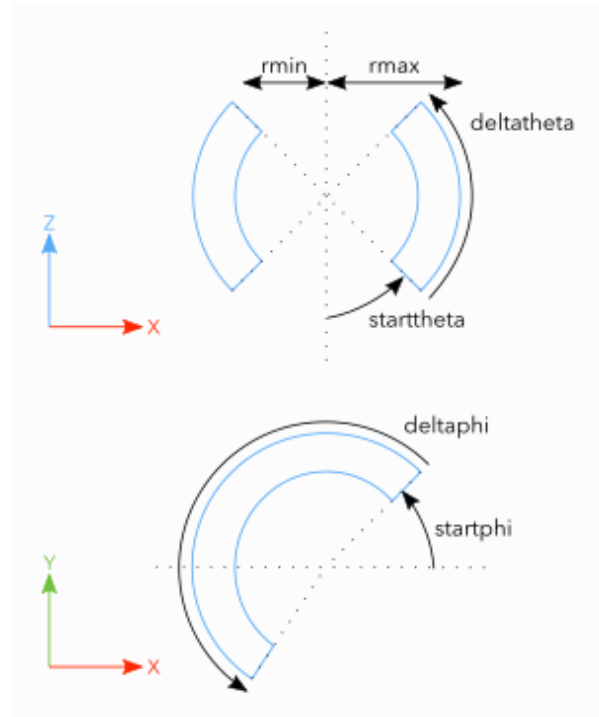

Figure 22: Sphere parameters

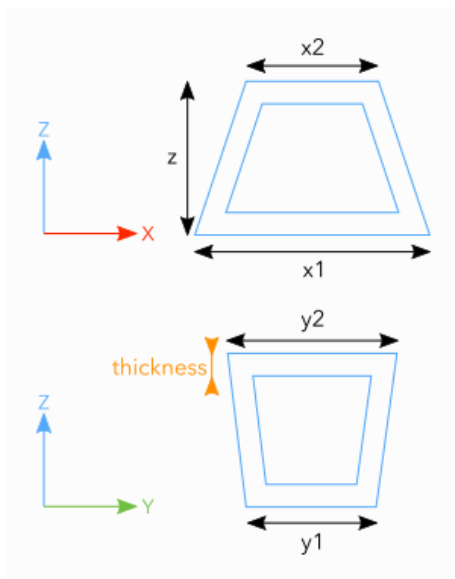

Figure 23: Trapezoid parameters

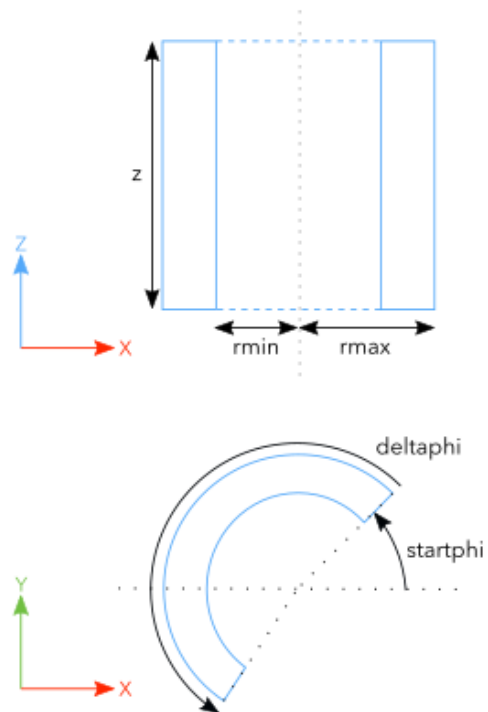

Figure 24: Tube parameters

5.3. Other shapes available

5.3.1. Tessellated Solid

Solids with complex geometries can be constructed by importing tessellated surfaces, including initially B-Rep based models. Numerous formats are supported (.geo, mesh file, STEP AP 203 – 214 ...). Those tessellated surfaces are converted into an equivalent GDML tessellated solid object.

Please notice that the imported tessellated surface must imperatively be a close surface. EDGE displays a warning message to the user if it is not the case.

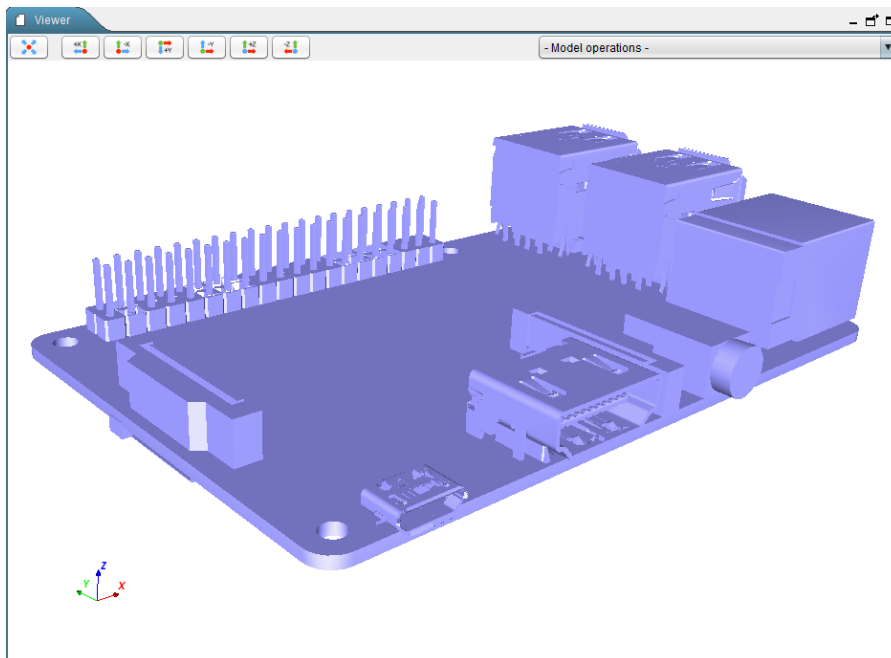

Figure 25: Example of an imported tessellated solid

5.3.2. Assemblies

In EDGE, the user has the possibility to handle “assembly” elements. Those elements are grouping several shapes without being attached to a geometric shape.

5.3.3. GDML file

EDGE also allows importing all the geometry concepts from another GDML file and including them as a child of the currently selected element. This option can be very useful if users want to check the position of a specific subsystem (defined in the imported GDML file) in the whole system (main GDML file). An example is shown on Figure 26.

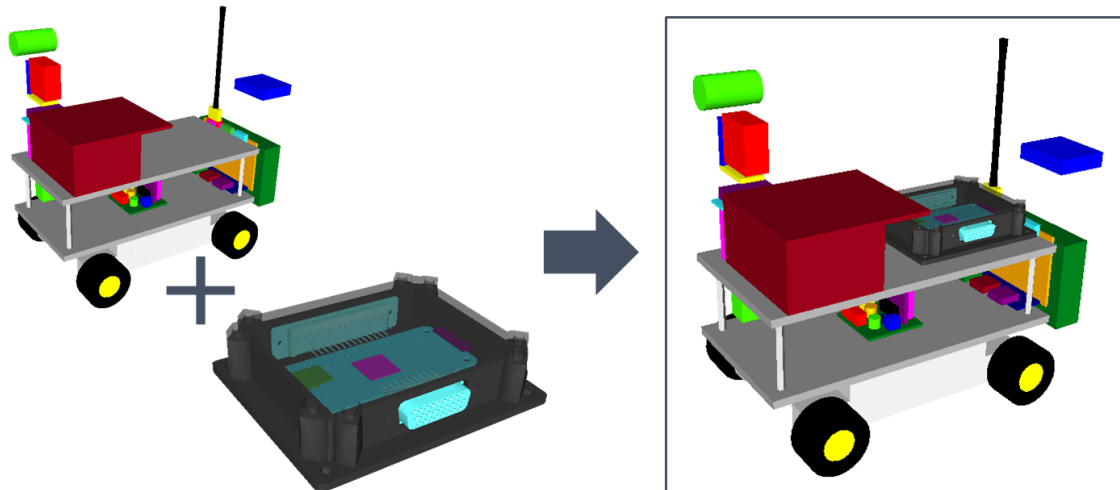



Figure 26: Example of import of GDML file

5.4. Edition of the geometry

5.4.1. Creating/adding a new shape

The user has first to create a “world” shape that will include all subsequent shapes. The position (0, 0, 0) corresponds to the barycentre of this world shape. Once this is done, it is possible to start the construction of the desired object.

NB: Even if technically GDML allows creating a world smaller than the final object, it is not recommended. The world shape typically corresponds to the computational domain of numerous of simulation software using GDML files in input. And most of these tools will not work properly nor give relevant results if the world shape does not encapsulate all other elements. The relevant definition of the world shape remains on the responsibility of the user and with respect to the final targeted application.

Clicking on the “” button (or the Add the world shape / “ Add a new shape ...” link if the corresponding option in the Preferences is enabled, see section 4), calls the New Shape Wizard (Figure 27). On the left panel of the dialog box, all the available shapes are represented. A click on a shape selects it and shows its properties on the right panel. Properties requirement varies with the different shapes, but for each ones the Name, Unit Configuration, Position and Rotation can be informed. All the properties can be edited via the Properties Panel (Figure 8, box 2).

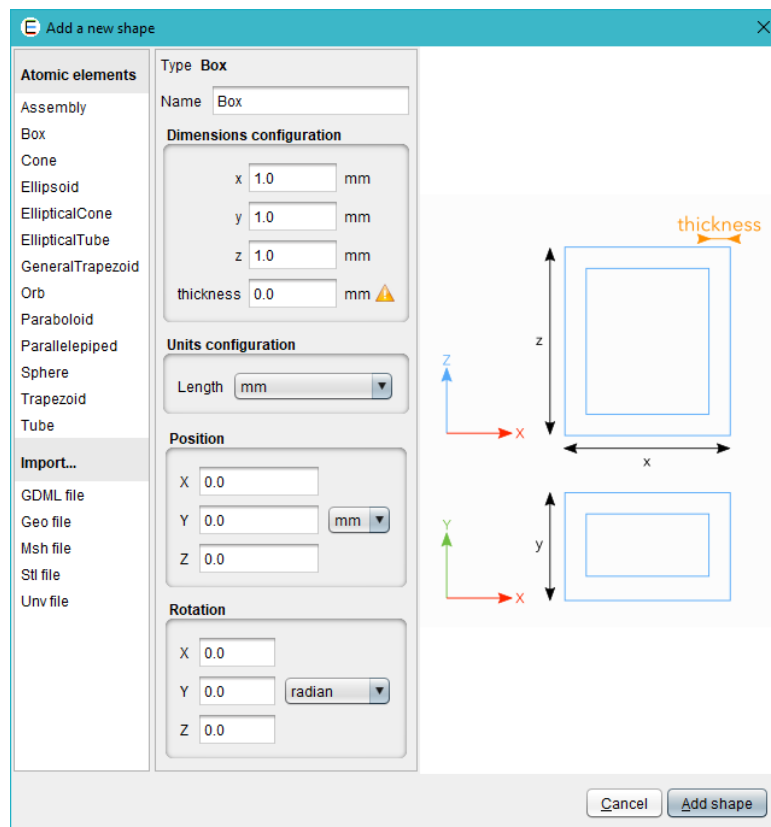



Figure 27: New shape dialog box

If the tree is empty, the first new shape will become the “world” shape. After that, each new shape will be added to the tree as a child of the current selected element. If no element is selected, the new element will be added as a child of the “world box”. This feature makes possible the creation of objects with a complex hierarchy of objects.

The new shape dialog box displays all the available import options which may vary depending on the installed plug-ins. Basic ones are the B-Rep format files import (.geo, .msh, .stl, .unv), or the GDML file import.

5.4.2. Transforming several elements

Position and orientation can be directly edited in the properties panel. However, as it is not convenient to use this feature on each element to move, a multi-transformation tool has been implemented, accessible via the “Transform” icon of the Shapes tree panel (see section 5.1.1).

Once the elements to modify in the tree are selected, click on the Transform button () . The dialog box showed in Figure 28 then appears.

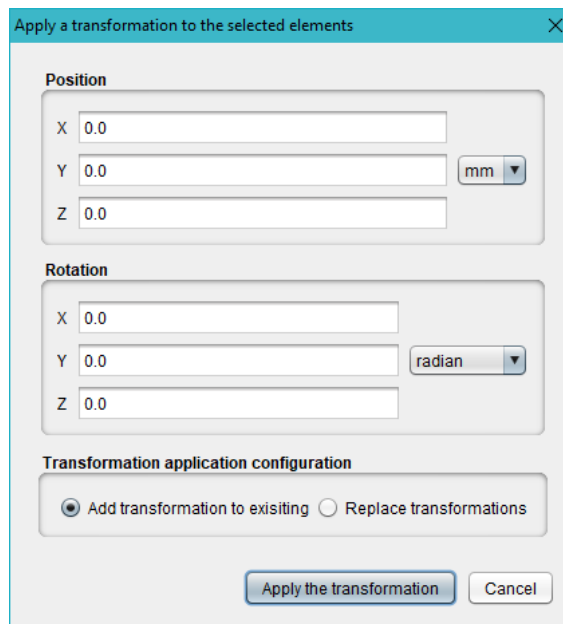

Figure 28: Multi-element transformation dialog

This dialog box allows setting the translation and rotation to apply to the elements. These transformations can replace the current position and orientation properties of the objects or be added to any existing placement information. For example, for an object at a (1, 1, 1) position, a transformation of (2, 0, 0) with “Add” will displace the object to (3, 1, 1), when “Replace” will displace it to (2, 0, 0).

5.5. Model operations

The user can perform operations on the created CAD model thanks to the drop-down menu “Model operations”. The list of available operations may be subject to changes depending on both the version and the license of EDGE used. Available operations by default are:

5.5.1. GDML File validity check

This operation checks the syntax validity of a GDML file against the GDML file format specifications. It is possible to check the current file (if saved beforehand) or any file from the system. The Figure 29 shows the tool appearance.



Figure 29: GDML file validity check tool

5.5.2. Check for overlaps

This operation allows the user to check if there are no overlaps inside the geometry, meaning that there are no shapes overlapping each other. The user can choose if “touching” shapes should be considered as overlapping or not. To launch the calculation, the user can click on the “Play” button. The “Stop” button allows the user to stop the calculation at any time. The results of the operation are presented on Figure 30.

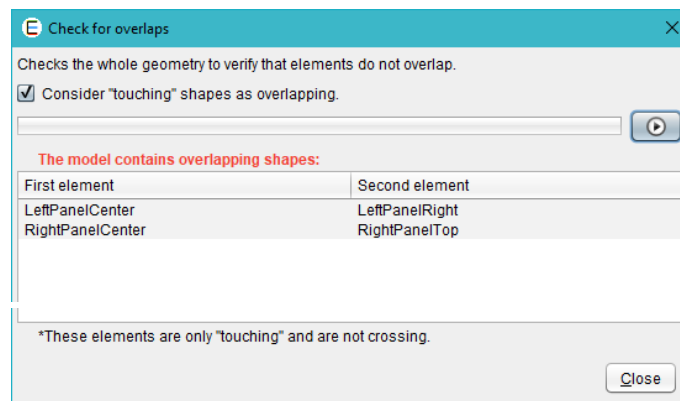
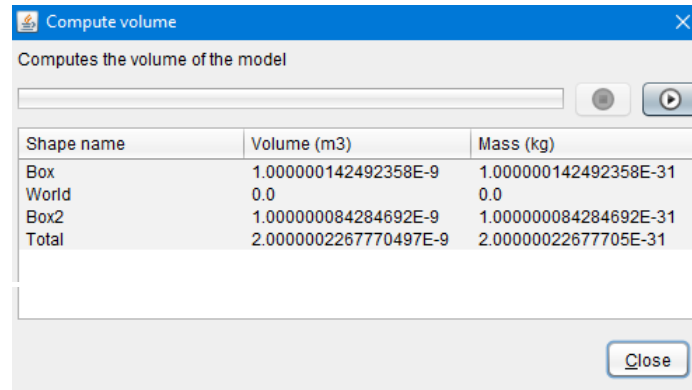

Figure 30: Overlaps calculation results
(indicates that the LeftPanelCenter and RightPanelCenter elements are overlapping)

5.5.3. Compute volume

This operation allows the user to obtain the volume of the geometry. The computed value is an approximation of the real volume value based on 3D meshing of the shapes. As for the previous operation, the calculation is launch with the “Play” button and can be stopped with the “Stop” button (cf. Figure 31).



Shape name	Volume (m3)	Mass (kg)
Box	1.000000142492358E-9	1.000000142492358E-31
World	0.0	0.0
Box2	1.000000084284692E-9	1.000000084284692E-31
Total	2.0000002267770497E-9	2.00000022677705E-31

Figure 31: Volume computation results

5.5.4. Reorganise model

This operation allows the user to check the consistency of the hierarchy of the model. Indeed, to get proper radiations results, elements that are included in other ones (geometrically) should be placed as child of the geometrical shapes they are in. This tool computes the real hierarchy, displays the results to the user and proposes to modify the model accordingly. NB: due to current limitation on this tool, it will remove all assemblies from the model.

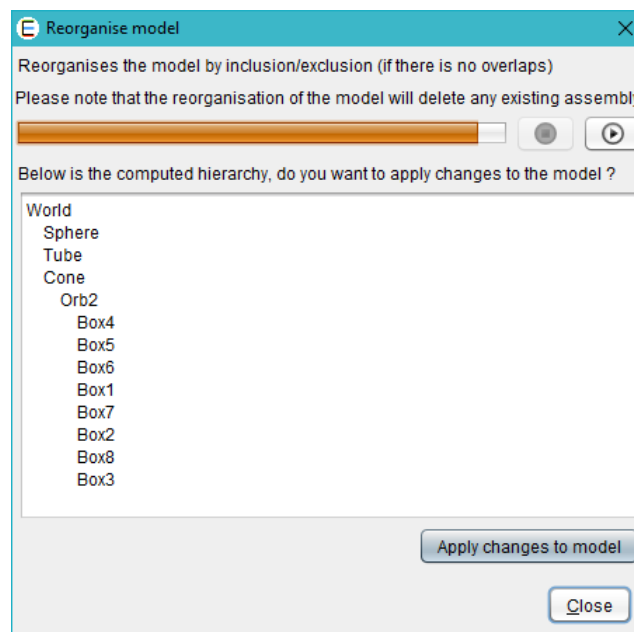

Reorganises the model by inclusion/exclusion (if there is no overlaps)
Please note that the reorganisation of the model will delete any existing assembly.

Below is the computed hierarchy, do you want to apply changes to the model ?

```

World
  Sphere
  Tube
  Cone
  Orb2
    Box4
    Box5
    Box6
    Box1
    Box7
    Box2
    Box8
    Box3
  
```

Apply changes to model

Close

Figure 32: Exemple of hierarchy reorganisation results.

5.5.5. SSAM – Sector Shielding Analysis Module

Important remark: Access to this operation is provided through an additional plug-in and may require an additional license and/or depends on your EDGE license. Please, send an email to contact_at_space-suite.com for more information. SAAM is not provided with the default packing of the EDGE. Please section 3.3.1 for further information regarding the installation procedure.

SSAM is used to perform a sector shielding analysis on the CAD model in EDGE. Using a ray-tracing technique, SSAM will perform, from a target point of view, an evaluation of the shielding thickness in all directions of a selected angular sector. The target can typically be a sensitive device on which the user wants to evaluate radiations effect. Taking into account the nature of attributed materials, the geometrical thickness is converted into aluminium effective one. For this reason, please note that the geometry must be properly defined and materials assigned to it in order to use SSAM.

To launch SSAM, select SSAM in the model operation list.

SSAM needs the following input parameters as illustrated in Figure 33:

- the position where to perform sector shielding analysis (x, y, z and length unit);
- the number of sphere sectors around this point to divide the space in theta(θ) and phi(ϕ) directions – with theta varying between 0 and 2π phi varies 0 and π ;
- the total number of rays to launch for the sector shielding analysis.

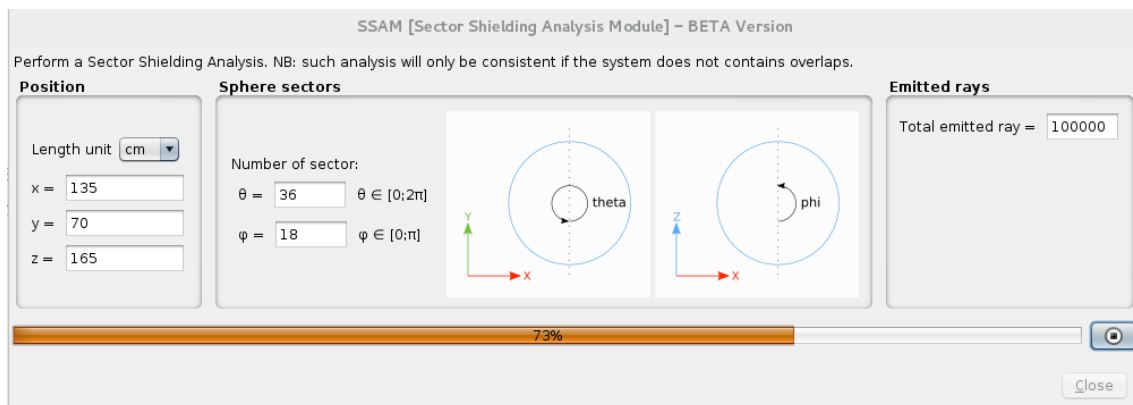



Figure 33: inputs parameters for SSAM

Click on the  button to launch SSAM. From the defined position, the selected number of rays is launched in all directions (using an isotropic distribution). SSAM computes the distance in each material density type crossed by the ray and calculates the equivalent thickness of Aluminium defined by a density of 2.699 g/cm^3 . All these results are then summarised for each sphere sector computing the minimal, mean and maximal of the equivalent thickness of Aluminium.

NB: Please note that SSAM also check if there is no overlap in the geometry to avoid problems during the calculations. If it detects overlaps, the computation will stop with a message explaining it.

SSAM results are displayed after all the rays are launched. There are several areas to display SSAM results as illustrated in Figure 34.

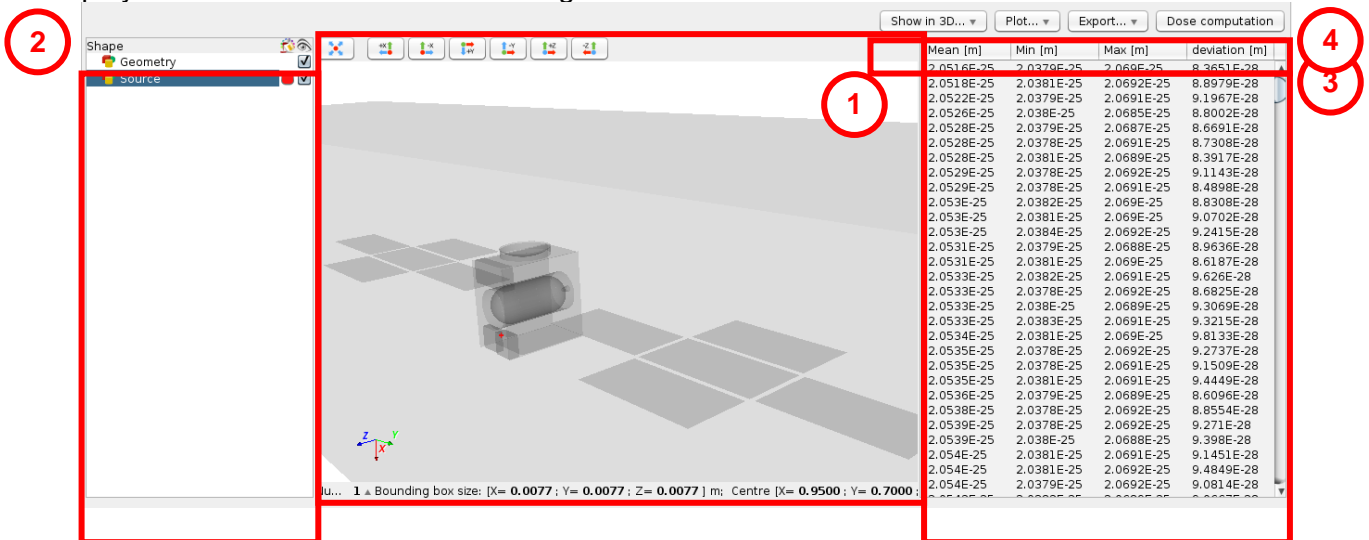

Figure 34: SSAM results

The panel labelled “1” presents a 3D view of the different results computed with SSAM.

The panel labelled “2” lists these the elements and allow to change their visibility, transparency and colours by clicking on the corresponding checkboxes and coloured buttons. By default, the modelling geometry is displayed in transparency and in black colour. The position of the target is represented by a red sphere. Please note, in some cases, this sphere can be small compared to the global geometry size and a zooming might be needed to see it.

In the panel labelled “3”, a table is displayed with 4 columns and several rows. Each row is the result of a sphere sector defined by a division in theta and phi directions described by the input parameters. The columns are respectively the mean, the minimum, the maximum and the standard deviation of the mean values of the equivalent thickness of aluminium in this sphere sector. All these values are expressed in metre. The standard deviation is computed with the following formula, with “nb of ray” the total ray launched in the sphere sector, “ t_i ” the equivalent thickness of the ray i , “ t_{mean} ” the mean of all equivalent thicknesses in the sphere sectors:

$$deviation = \sqrt{\frac{\sum_{i=1}^{nb \text{ of ray}} (t_i - t_{mean})^2}{nb \text{ of ray} - 1}}$$

The contextual menu bar labelled “4” provides several possibilities to displays the selected results in the 3D view or as plots, export them into CSV format files or to compute the dose received by the target.

The “Show in 3D...” menu allow to display results in the 3D view. The selected result appears in the 3D view and is listed in the control panel “2” (cf. Figure 34). The following 3D representations are available:

- The minimum, mean or maximum of the equivalent aluminium thickness for each sphere sector. More information about each sphere sector can be obtained by clicking on each sphere sector item in the list of 3D items. An example of such representation, commonly called “hedgehog view”, is in Figure 35 (a);
- The average sphere considering the mean of the equivalent aluminium thickness for all rays launched by SSAM. The details regarding this sphere, like the diameter can be displayed by clicking on the item in the list of 3D items. The information bar at the bottom of the 3D view gives the size of the selected element bounding box enabling to quickly access the size of the sphere;
- The number of interceptions for each face of the geometry. This 3D result can be used to check if enough rays have been launched to provide a statistic good enough: if a face has zero interceptions, it indicates that not enough rays has been launched to intercept this face. When selecting this results in the list of 3D items, a scalar bar appears helping assess the value represented by each colour;
- The minimum, mean or maximum hollow sphere sectors of equivalent aluminium thickness. Users must set the inner radius of the hollow sphere, and the space between each sphere sector. The details of each hollow sphere sector are available by clicking on each sphere sector item in the list of 3D results. An example of this result is shown in Figure 35 (c).
- A coloured sphere where each colour represents the value of the equivalent thickness of Aluminium in metre. When selecting this results in the list of 3D items, a scalar bar appears helping assess the value represented by each colour. An example of this result is shown in Figure 35 (d).

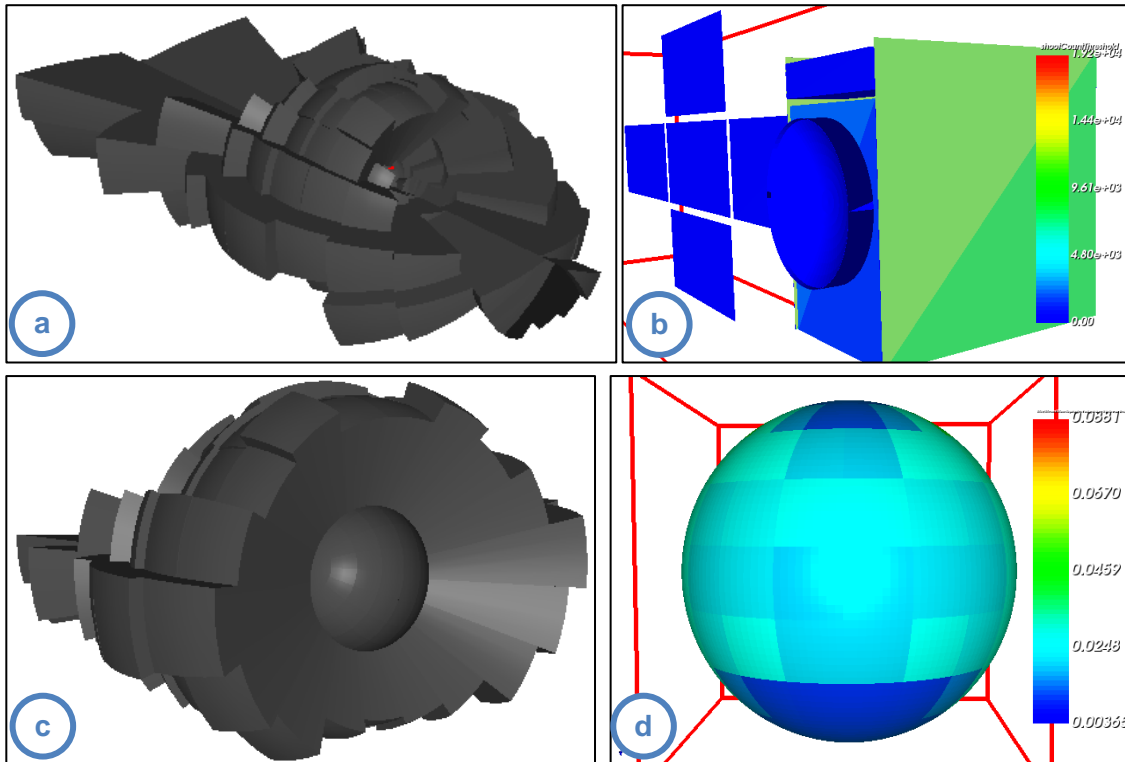

Figure 35: available 3D results: (a) 3D sphere sectors results or “hedgehog view” (b) number of intercepting rays for each face (c) 3D hollow sphere sectors results (d) sphere sector aluminium equivalent thickness mapped on a coloured sphere

The “Plot...” menu enables to display plots of meaningful results into new pop-ups windows. The following results are available:

- $y = f(x)$ chart type where the minimum, the mean and the maximum of the equivalent thickness of Aluminium in metre for each sphere sector is displayed. An example is shown in Figure 36;
- $y = f(x)$ chart type with the mean of the equivalent thickness of Aluminium in metre and its standard deviation are displayed for each sphere sector. An example is shown in Figure 37;
- A 2D Map showing the angular repartition of the equivalent thickness of Aluminium for each sphere sector. An example is shown in Figure 38.

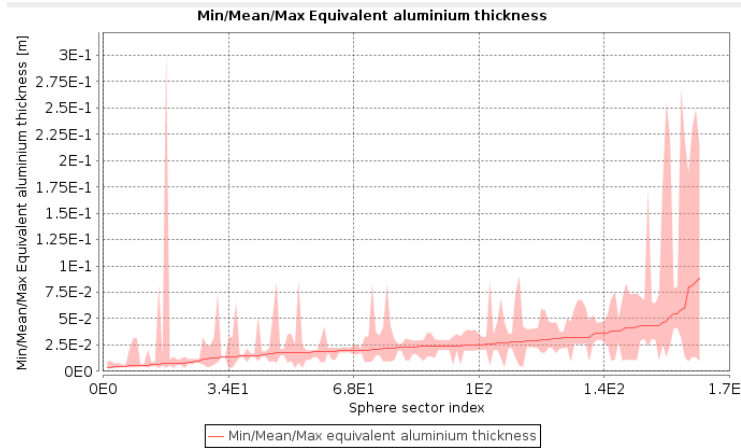

Figure 36: minimum, mean and maximum equivalent thickness of Aluminium in metre for each sphere sector.

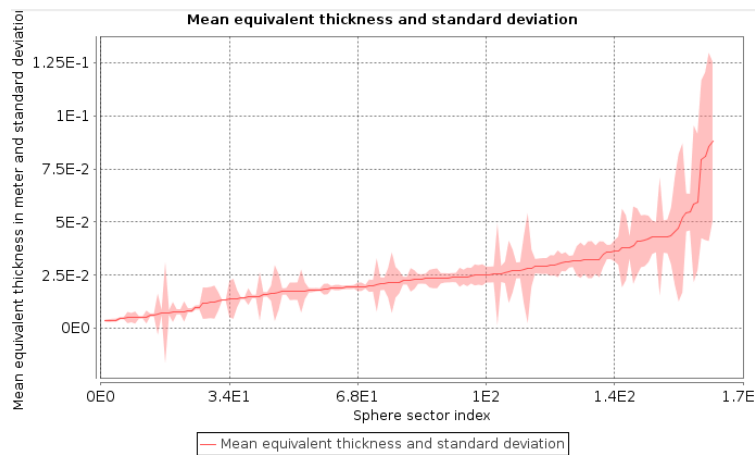

Figure 37: The mean of the equivalent thickness of Aluminium and its standard deviation in metre for each sphere sector

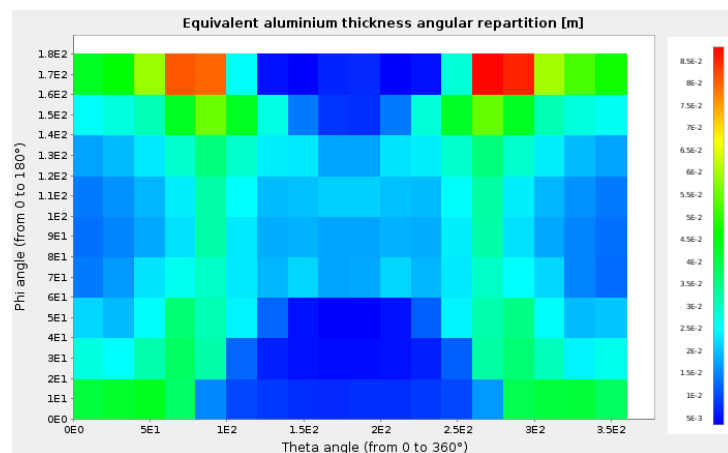

Figure 38: the angular repartition of the equivalent thickness of aluminium in metre for each sphere sector

The “Export...” menu enables to save the following results on the disk:

- The equivalent thicknesses of Aluminium in metre to a CSV file;
- An equivalent sphere with a radius equal to the average of the equivalent thicknesses of Aluminium of all rays used for SSAM. This sphere is exported to a GDML file;
- The number of rays which intercepted each face of the geometry in a VTK file;
- The hollow sphere sectors using the minimum, the mean or the maximum of the equivalent thickness of Aluminium of all sphere sectors. The hollow sphere sectors are exported to a GDML file. Users must set the radius of the hollow sphere, and the space between each sphere sector to avoid cross contacts and overlapping between sectors to respect GEANT4 constraints.

The “Dose computation” menu, opens a new popup, as illustrated in Figure 39, to compute the cumulative dose based on the previous computed aluminium equivalent thicknesses. Users must beforehand set the tabulated function defining the evolution of the cumulative dose versus the depth of a material, using external software, models or experimental data. The user may, for instance, use the Shildose2 model, as provided in the frame of the ESA/BIRA/Spennis online application.

It is possible to set it manually directly in the editor or to load a csv file with two columns separated by a comma. The first column defines the depth and the second one the dose. An example of such file is in the section 10 page 45 and also in the “data” directory of EDGE.

Additionally, it is also necessary to set the unit of the two axes: Gray or Rad for the dose and g/cm² or millimetre of a material with a specific density for the depth. If the selected unit is g/cm², then it is not necessary to set the density because the results do not depend on the density of the material. Finally, on the right part of the editor, the points of the tabulated function are displayed.

When the inputs parameters for the dose computation are set, users can click on the  button. Both the equivalent thickness of Aluminium of each sphere sector and the dose versus depth tabulated function are used to compute the deposited dose using the following formula, where Ω_i is the surface of the sphere sector i , $D(T_i)$ is the dose for the equivalent thickness of Aluminium of the sphere sector i :

$$TotalDose = \frac{1}{4\pi} \sum_i^{sphereSectors} \Omega_i D(T_i)$$

Then a new popup appears with the results of the cumulative dose **Error! Reference source not found.** The results are computed considering the minimum, the mean and the maximum of the equivalent thickness of Aluminium for all sphere sectors. Users can choose to save these results in a dedicated file by clicking on the  button.

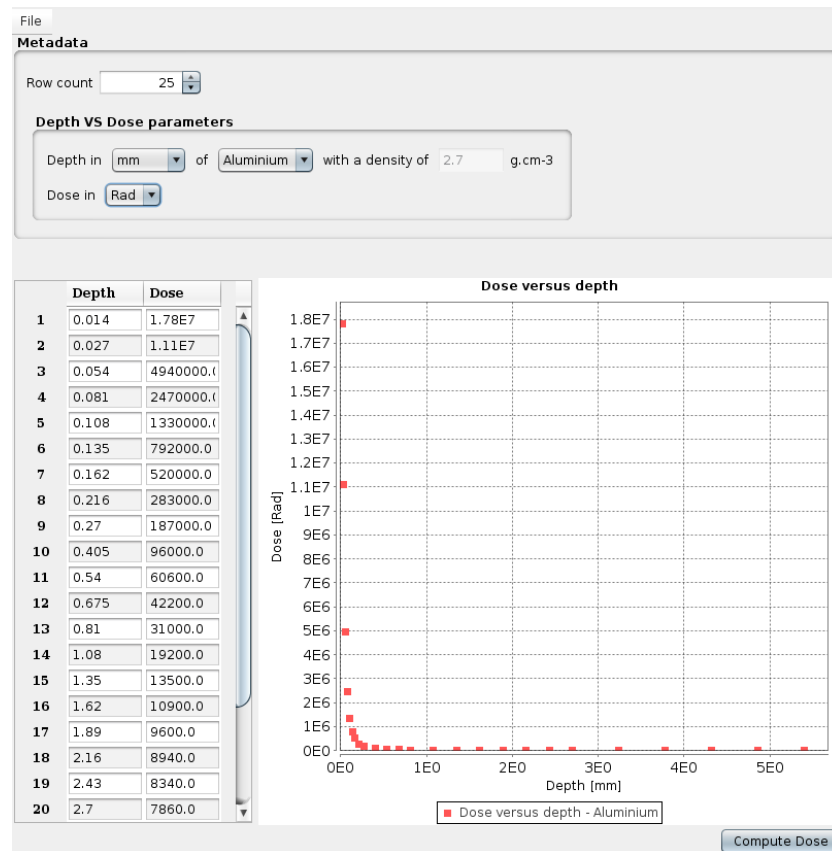

Figure 39: Dose computation input parameters

Important remark: Please pay attention the sector shielding analysis approach implies the particle transport through the matter be averaged as straight lines from the sources to the target, without scattering, diffusion, secondary particles emissions. This may constitute a severe assumption in some cases, like for electrons diffusion. Moreover, the position of the punctual target, as defined in SSAM, may deeply impact the effectively viewed shielding, i.e. effect of point-of-view, and the total cumulated dose of a larger sensitive component, with a spatial extension, be significantly differ. For these reasons, results computed with a sector shielding analysis should be considered with care and remain of the full responsibility of the end user and his expertise.

Please contact us for further support by our experts and/or advanced studies (contact@space-suite.eu).

6. Material definition

The aim of this perspective is to define materials that will be attributed later to a geometric shape.

The Material definition perspective has no 3D view but is composed of three main panels, as shown on Figure 40:

- ① **Materials list**, the list of user-defined materials;
- ② **Geant4 Materials**, the list of available Geant4 default materials;
- ③ **Material editor**, panel to edit the currently selected material.

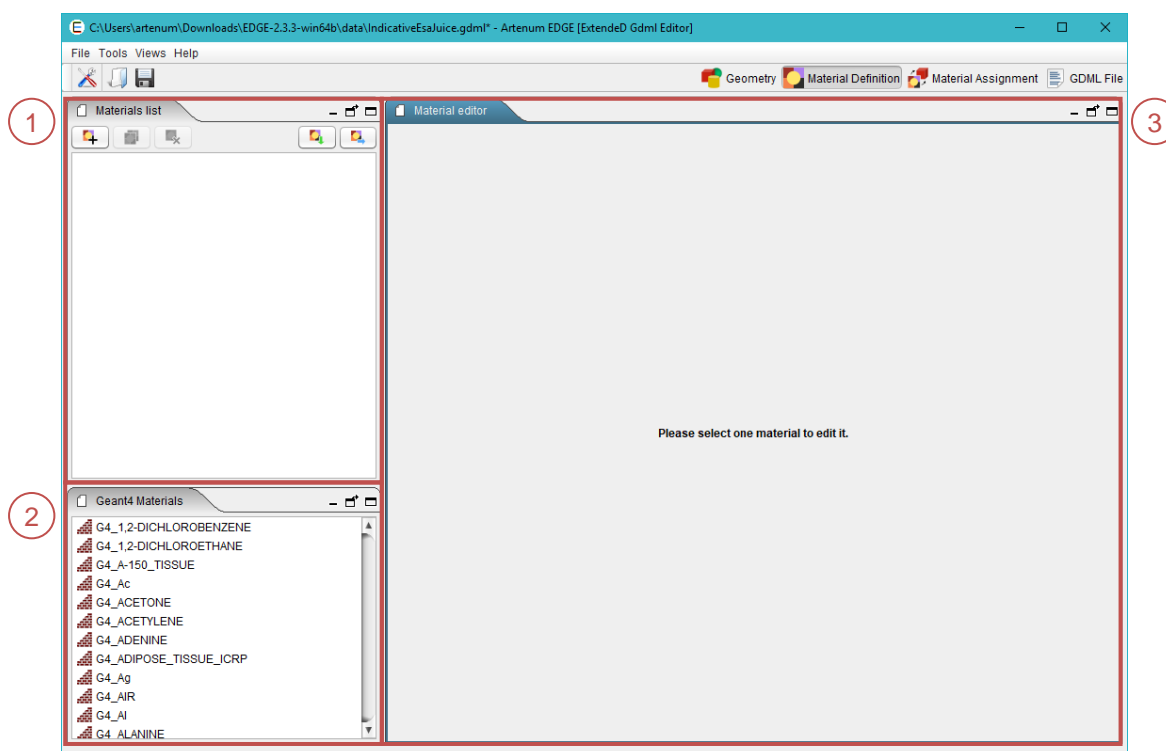

Figure 40: EDGE material definition view

6.1. About GDML materials

In GDML format, materials are defined by their isotopic and stoichiometry compositions. Materials can be defined by a single “atom”, a composition of elements or fractions of elements.

These elements can be simple “atom” or represent an isotropic distribution. Figure 42 presents different examples of material defined using the GDML formalism.

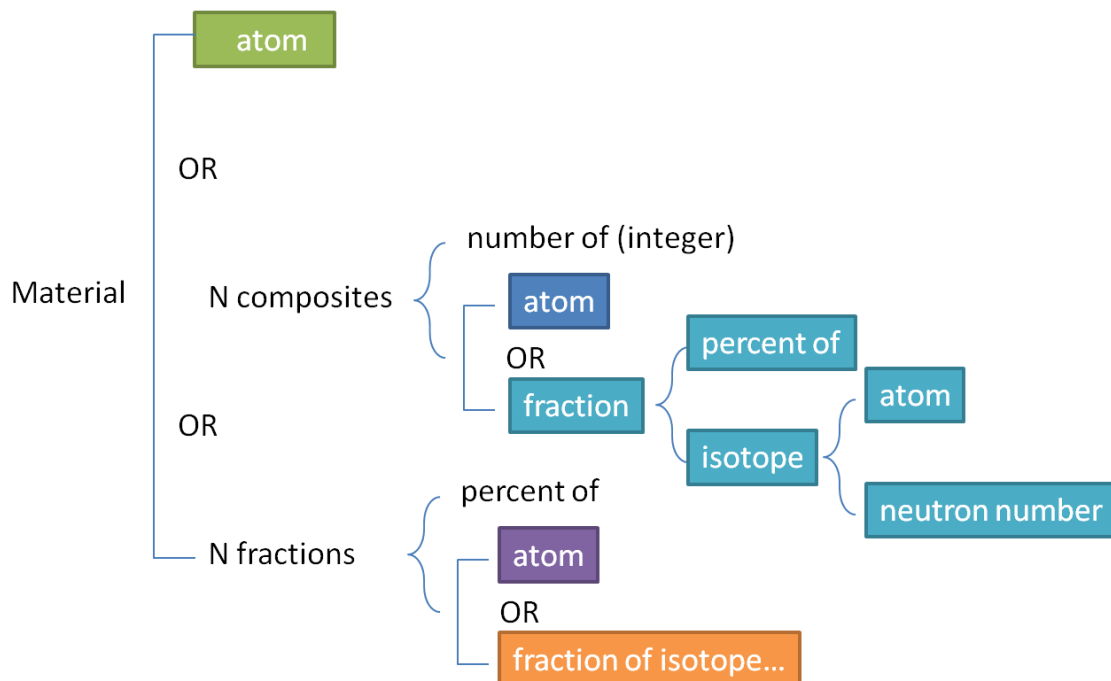

Figure 41: Material definition in GDML



Helium	2 Hydrogen 1 Oxygen	2 (0.99988 of ¹ H and 0.00012 of ² H) 1 (0,9975 of ¹⁶ O, 0.0004 of ¹⁷ O and 0,0021 of ¹⁸ O)
0.01 of Carbon	0.01 of (0.9893 of ¹² C and 0.0107 of ¹³ C),	
0.17 of Chromium	0.17 of (4.34% of ⁵⁰ Cr, 83.79% of ⁵² Cr, 9.5% of ⁵³ Cr and 2.37% of ⁵⁴ Cr)	
0.82 of Iron	0.82 of (5,85 % of ⁵⁴ Fe, 91,75 % of ⁵⁶ Fe 2,12 % of ⁵⁷ Fe and 0,28 % of ⁵⁸ Fe)	

Figure 42: Examples of different ways of defining a material in GDML

6.2. Materials list

Creating a material is performed by clicking on the “*add material button*” ().

Warning: *If the user creates a new material which is not attributed to a geometrical shape in the Materials affectation perspective, this material will not be saved inside the generated .gdml file when the user saves the file to GDML in EDGE. In order to save materials which are not attributed inside the .gdml file, the user needs to activate the option “Write non-used user-defined materials”, see section 4.2.*

In order to edit a material, a click on an element in the list updates the material editor with the current material where it can be edited (see section 6.4). It is possible to duplicate a material by clicking on the “*duplicate button*” (). Those new materials are added at the end of the materials list and their names are incremented in order to not confuse them with the initial materials. Deleting a selected material is performed by clicking on the “*delete button*” (.

By clicking on the “*import materials button*” () , it is possible to import materials from another GDML file or from a GDML materials the EDGE XML file format. In the case of a GDML file, this mechanism will import all materials written inside the GDML file. We remind that in order to write all materials in a GDML file, even the ones, which are not assigned to a geometry shape, the user must enable the corresponding option in the Preferences (see section 4.2).

Finally, clicking on the “*export materials button*” () exports the materials into a GDML material file (.xml). All the user-defined materials will be exported.

6.3. Geant4 materials

Available Geant4 materials for the material assignment (see section 7) are displayed in the Geant4 materials panel, as shown on Figure 40.

6.4. Material editor

The material editor is separated in two main parts: the first one on the top is the same for every material allows defining the name, the density and other properties of the material. Below, a section enables to define the composition of the material and changes depending on the type of chosen material. Figure 43 below shows the editor for a simple “atom” material. On the top, it is possible to fill in the material name, the density in g/cm^3 and optional properties before choosing the type of material.

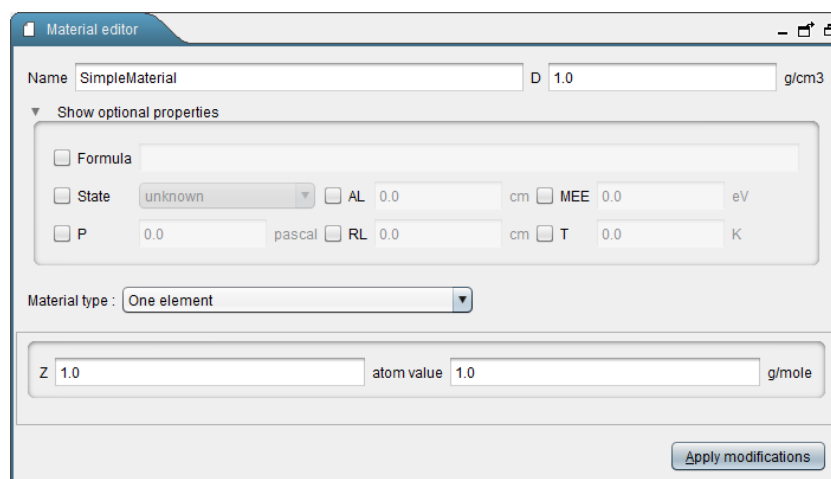

Figure 43: Material editor for an "atom" material showing the optional properties

General optional properties can be set by clicking on the “Show optional properties” and are:

- The choice of the atomic number Z;
- The formula;
- The state (liquid, solid, gaseous);
- The absorption length (AL);
- The mean excitation energy (MEE);
- The pressure (P);
- The radiation length (RL);
- The temperature (T).

The user can then choose a material type. As shows Figure 41, a material can be defined by three different ways.

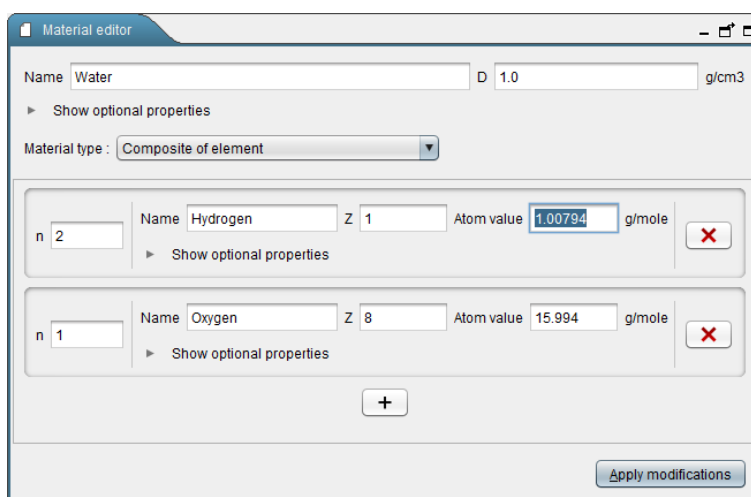

Figure 44: Material editor for a composition of element (here water)

Figure 44 shows the material editor for a composition of elements. These elements are similar to atom shown previously but can have additional meta-data attached to them using the “*Show optional properties*” button. The number of each element is chosen on the left with the “*n*” field. It is easy to add and remove elements just by clicking on the (+) button and (X) respectively.

It is possible to define material with isotopes instead of elements. In this case each element is made of fractions of isotopes. Also, it is possible to define a material with fractions of elements/isotopes instead of compositions.

To apply the modifications, it is necessary to click on the “*Apply modifications*” button.

7. Materials assignment

The aim of this perspective is to apply the materials defined in the material definition view to the geometry defined in the geometry edition view. Thus, this view only makes sense when at least one shape has been defined in the geometry perspective.

The materials assignment perspective has the same 3D view as the geometry one (like shown on Figure 45):

- ① **Materials list**, list of the geometric shapes and their currently applied material;
- ② **Material selection**, panel to select the material for the currently selected shapes.

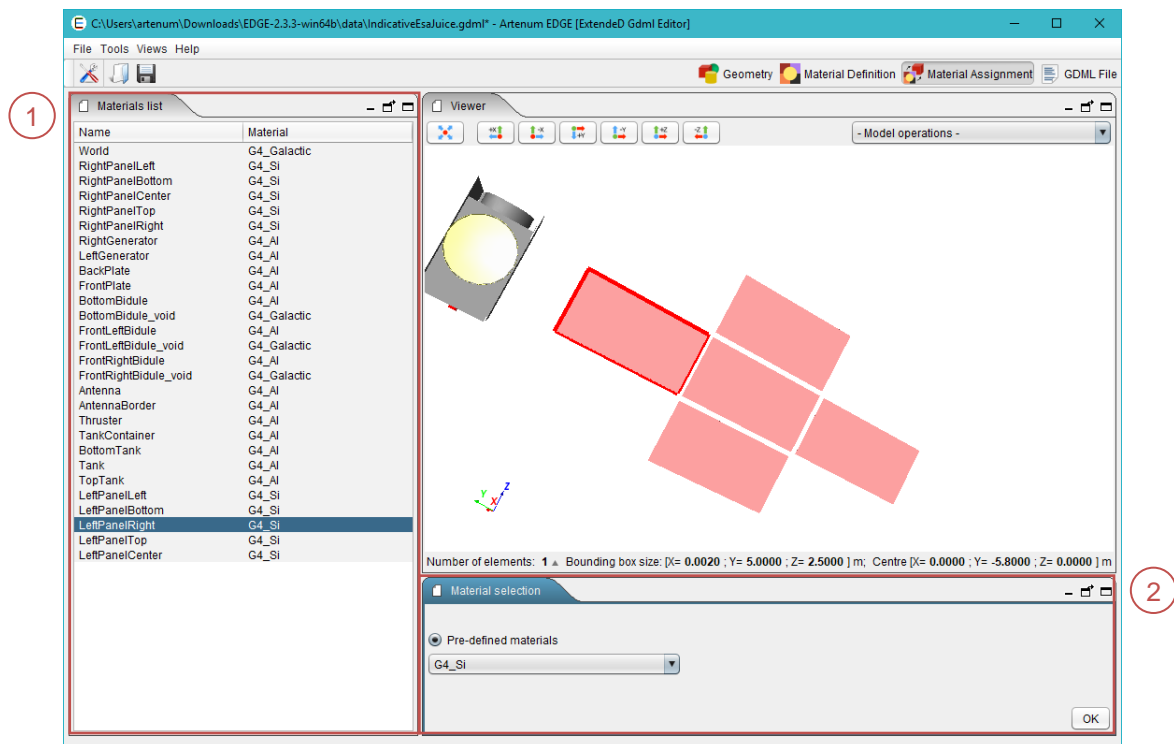

Figure 45: EDGE material edition view

7.1. Materials list

This panel contains a table with two columns. The first column (on the left) lists the geometry shapes created in the Geometry edition perspective. The second column (on the right) lists the materials attributed to each corresponding geometry shape.

By default, the Geant4 material “G4_Galactic” (i.e. space environment) is attributed to the geometry shape representing the world. All other geometry shapes created are, by default, composed of “Default_Material”. This behaviour can be changed in the Preferences, see section 4.1.

7.2. Material selection

The Material selection panel allows the user to select the material to attribute to a geometry shape, defined in the Geometry edition perspective.

When a geometry shape is selected in the Material list panel, the Material selection panel displays several choices for the user:

- **Pre-defined materials:** some pre-defined materials exist (see section 6.3) and can be directly used to define the material for the selected shape. When this option is selected, a drop down list appears, displaying all default materials already available in EDGE (the embedded “*Default_Material*” and all Geant4 materials).
- **Custom materials:** When this option is selected, a drop down list appears, displaying all the materials created in the Material definition perspective.

When the chosen materials are selected in the drop down list, the modification must be saved by clicking on the “OK” button.

8. GDML File perspective

EDGE provides a rich text-editor to complete the capabilities of the GUI and let the user freely edit and extend the generated GDML file and currently loaded in EDGE. The perspective is dedicated this editor and shown on Figure 46.

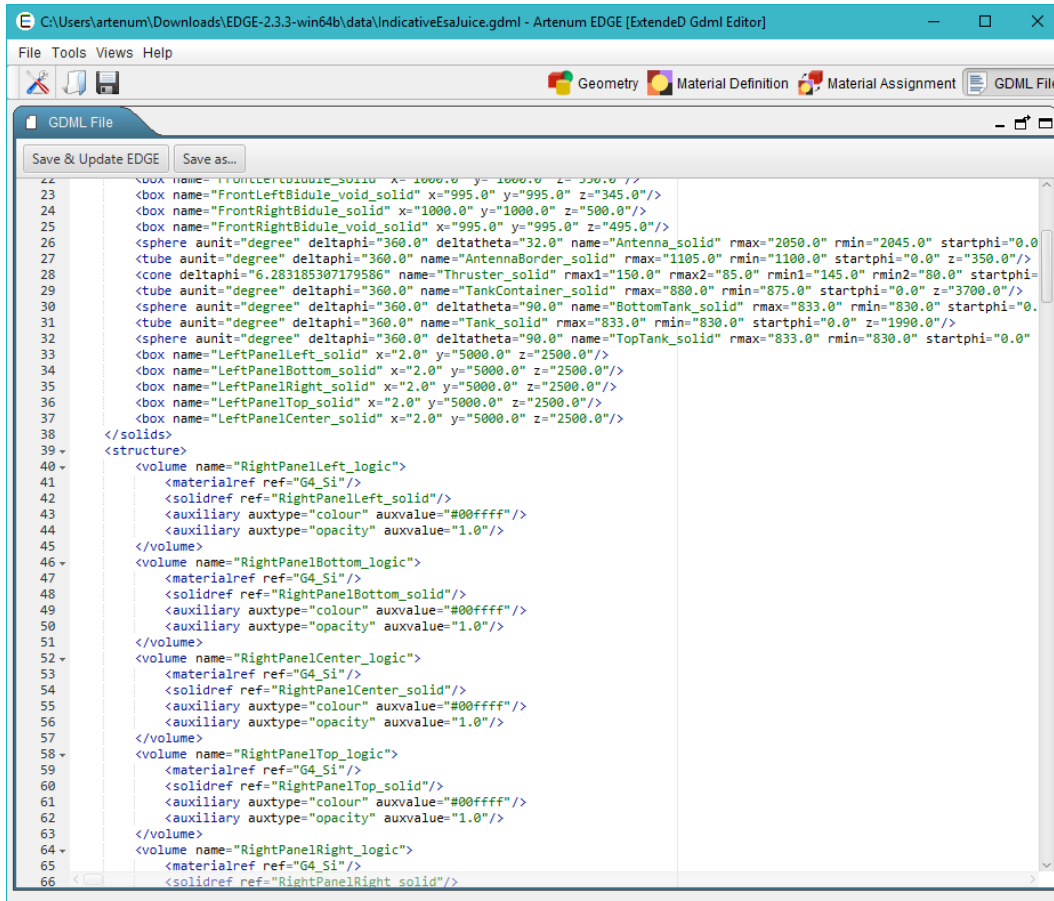

```

C:\Users\artenum\Downloads\EDGE-2.3.3-win64b\data\indicativeEsajuice.gdml - Artenum EDGE [ExtendE D Gdml Editor]
File Tools Views Help
Geometry Material Definition Material Assignment GDML File
GDML File
Save & Update EDGE Save as...
23 <box name="FrontLeftBidule_void_solid" x="995.0" y="995.0" z="345.0"/>
24 <box name="FrontRightBidule_solid" x="1000.0" y="1000.0" z="500.0"/>
25 <box name="FrontRightBidule_void_solid" x="995.0" y="995.0" z="495.0"/>
26 <sphere aunit="degree" deltaphi="360.0" deltateta="32.0" name="Antenna_solid" rmax="2050.0" rmin="2045.0" startphi="0.0
27 <tube aunit="degree" deltaphi="360.0" name="AntennaBorder_solid" rmax="1105.0" rmin="1100.0" startphi="0.0" z="350.0"/>
28 <cone deltaphi="6.283185307179586" name="Thruster_solid" rmax1="150.0" rmax2="85.0" rmin1="145.0" rmin2="80.0" startphi=
29 <tube aunit="degree" deltaphi="360.0" name="TankContainer_solid" rmax="880.0" rmin="875.0" startphi="0.0" z="3700.0"/>
30 <sphere aunit="degree" deltaphi="360.0" deltateta="90.0" name="BottomTank_solid" rmax="833.0" rmin="830.0" startphi="0.
31 <tube aunit="degree" deltaphi="360.0" name="Tank_solid" rmax="833.0" rmin="830.0" startphi="0.0" z="1990.0"/>
32 <sphere aunit="degree" deltaphi="360.0" deltateta="90.0" name="TopTank_solid" rmax="833.0" rmin="830.0" startphi="0.0"
33 <box name="LeftPanelLeft_solid" x="2.0" y="5000.0" z="2500.0"/>
34 <box name="LeftPanelBottom_solid" x="2.0" y="5000.0" z="2500.0"/>
35 <box name="LeftPanelRight_solid" x="2.0" y="5000.0" z="2500.0"/>
36 <box name="LeftPanelTop_solid" x="2.0" y="5000.0" z="2500.0"/>
37 <box name="LeftPanelCenter_solid" x="2.0" y="5000.0" z="2500.0"/>
38 </solids>
39 <structure>
40 <volume name="RightPanelLeft_logic">
41 <materialref ref="G4_Si"/>
42 <solidref ref="RightPanelLeft_solid"/>
43 <auxiliary auxtype="colour" auxvalue="#00ffff"/>
44 <auxiliary auxtype="opacity" auxvalue="1.0"/>
45 </volume>
46 <volume name="RightPanelBottom_logic">
47 <materialref ref="G4_Si"/>
48 <solidref ref="RightPanelBottom_solid"/>
49 <auxiliary auxtype="colour" auxvalue="#00ffff"/>
50 <auxiliary auxtype="opacity" auxvalue="1.0"/>
51 </volume>
52 <volume name="RightPanelCenter_logic">
53 <materialref ref="G4_Si"/>
54 <solidref ref="RightPanelCenter_solid"/>
55 <auxiliary auxtype="colour" auxvalue="#00ffff"/>
56 <auxiliary auxtype="opacity" auxvalue="1.0"/>
57 </volume>
58 <volume name="RightPanelTop_logic">
59 <materialref ref="G4_Si"/>
60 <solidref ref="RightPanelTop_solid"/>
61 <auxiliary auxtype="colour" auxvalue="#00ffff"/>
62 <auxiliary auxtype="opacity" auxvalue="1.0"/>
63 </volume>
64 <volume name="RightPanelRight_logic">
65 <materialref ref="G4_Si"/>
66 <solidref ref="RightPanelRight_solid"/>

```

Figure 46: EDGE GDML file view

A rich text-editor shows how the GDML file would be generated on disk. The content of the editor is updated each time the perspective is opened.

It is possible to modify the GDML file directly by editing the generated content. Once modification performed, it is possible to reload the file into EDGE (to see the modifications in the 3D view for example) using the “Save&Update EDGE” button but it is also possible to save the produced content to the hard disk by using the “Save as...” button.

This editor provides a syntactic colorization and completion, this last one available by typing ctrl+space key combination.

NB: please note that this perspective is disabled in TRIAL mode of EDGE and you need the full version of EDGE to use it.

9. Annex A: Example of materials description

Here after is presented an example of material definition in GDML format (partial description).

```
<materials>
  <!-- Examples of basic or fundamental materials -->
  <element name="videRef" formula="VACUUM" Z="1">
    <atom value="1"/>
  </element>

  <element name="aluminum" formula="Al" Z="13">
    <atom value="26.9815"/>
  </element>

  <element name="carbon" formula="C" Z="6">
    <atom value="12.0107"/>
  </element>

  <element name="Hydrogen" formula="H2" Z="1">
    <atom value="1.01"/>
  </element>

  <element name="Nitrogen" formula="N2" Z="7">
    <atom value="14.01"/>
  </element>

  <element name="Oxygen" formula="O2" Z="8">
    <atom value="16.0"/>
  </element>

  <!-- Examples of complex or composite materials -->
  <material name="Mat_ALUMINUM" formula="ALUMINUM">
    <D value ="2.7000" unit="g/cm3"/>
    <fraction n="1.0000" ref="aluminum"/>
  </material>

  <material name="Mat_Kapton" formula="Kapton">
    <D value ="1.42" unit="g/cm3"/>
    <fraction n="0.0273" ref="Hydrogen"/>
    <fraction n="0.7213" ref="carbon"/>
    <fraction n="0.0765" ref="Nitrogen"/>
    <fraction n="0.1749" ref="Oxygen"/>
  </material>
</materials>
```

10. Annex B – Example of csv file for the dose computation

Here after is presented an example of csv file defining the dose in Rad versus the depth in g/cm² in a tabulated function for the dose computation. The first column is the depth and the second column is the dose

```
0.01, 1800000
0.03, 1100000
0.05, 500000
0.08, 250000
0.10, 130000
0.13, 79000
0.16, 52000
0.21, 28000
0.27, 19000
0.40, 10000
0.50, 6000
0.70, 4200
0.80, 3100
1.1, 1900
1.3, 1300
1.6, 1100
1.9, 1000
2.1, 900
2.4, 800
2.7, 750
3.2, 700
3.8, 650
4.3, 600
4.9, 570
5.4, 500
```

END OF DOCUMENT